

Nikon

The Nikon Guide to Digital Photography
with the

COOLPIX885

DIGITAL CAMERA

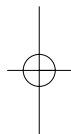
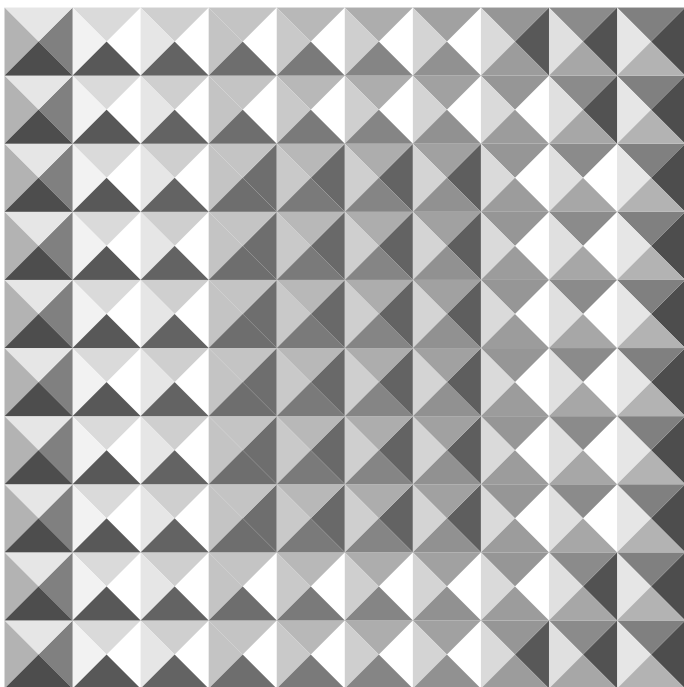

CE E

Product Documentation

The documentation for this product includes the manuals listed below. Please be sure to read all instructions thoroughly to get the most from your camera.

Quick-Start Guide

The Quick-Start Guide takes you through the process of unpacking and setting up your Nikon digital camera, taking your first pictures, and transferring them to your computer.

Guide to Digital Photography

The Guide to Digital Photography (this manual) provides complete operating instructions for your camera.

Nikon View Reference Manual

The Nikon View Reference Manual can be found in electronic format on the reference CD provided with your camera. For information on viewing the Reference Manual, see "Reference: Connections" in this manual.

To prevent damage to your Nikon product or injury to yourself or to others, read the following safety precautions in their entirety before using this equipment. Keep these safety instructions where all those who use the product will read them.

The consequences that could result from failure to observe the precautions listed in this section are indicated by the following symbols:



This icon marks warnings, information that should be read before using your Nikon product to prevent possible injury.



This icon marks cautions, information that should be read before using your Nikon product to prevent damage to the equipment.

WARNINGS

Do not look at the sun through the viewfinder

Viewing the sun or other strong light source through the viewfinder could cause permanent visual impairment.

Turn off immediately in the event of malfunction

Should you notice smoke or an unusual smell coming from the equipment or from the AC adapter (available separately), unplug the AC adapter and remove the battery immediately, taking care to avoid burns. Continued operation could result in injury. After removing the battery, take the equipment to a Nikon-authorized service center for inspection.

Do not use in the presence of flammable gas

Do not use electronic equipment in the presence of flammable gas, as this could result in explosion or fire.

Do not place strap around neck

Placing the camera strap around your neck could result in strangulation. Special care should be taken to avoid placing the strap around the neck of an infant or child.

Do not disassemble

Touching the product's internal parts could result in injury. In the event of a malfunction, the product should be repaired only by a qualified technician. Should the product break open as the result of a fall or other accident, remove the battery and/or AC adapter and then take the product to a Nikon-authorized service center for inspection.

Observe proper precautions when handling batteries

Batteries may leak or explode if improperly handled. Observe the following precautions when handling batteries for use in this product:

- Be sure the product is off before replacing the battery. If you are using an AC adapter, be sure it is unplugged.
- Use only the Nikon EN-EL1 lithium-ion battery or a 6V 2CR5 (DL245) lithium battery.
- When inserting the battery, do not attempt to insert it upside down or backwards.
- Do not short or disassemble the battery.
- Do not expose the battery to flame or to excessive heat.
- Do not immerse in or expose to water.
- Do not transport or store with metal objects such as necklaces or hairpins.
- Batteries are prone to leakage when fully discharged. To avoid damage to the product, be sure to remove the battery when no charge remains.
- When the battery is not in use, attach the terminal cover and store in a cool place.
- Immediately after use, or when the product is used on battery power for an extended period, the battery may become hot. Before removing the battery, turn the camera off and allow the battery to cool.
- When used with a 2CR5 (DL245) lithium battery, the camera grip may become noticeably warm, but this does not indicate a malfunction.
- Discontinue use immediately should you notice any changes in the battery, such as discoloration or deformation.

⚠ Use appropriate cables

When connecting cables to the input and output jacks, use only the cables provided or sold by Nikon for the purpose, to maintain compliance with product regulations.

⚠ Keep out of reach of children

Particular care should be taken to prevent infants from putting the battery or other small parts into their mouths.

⚠ Removing memory cards

Memory cards may become hot during use. Observe due caution when removing memory cards from the camera.

⚠ CD-ROMs

The CD-ROMs on which the software and manuals are distributed should not be played back on audio CD equipment. Playing CD-ROMs on an audio CD player could cause hearing loss or damage the equipment.

⚠ Observe caution when operating the flash

Using the flash close to your subject's eyes could cause temporary visual impairment. Particular care should be observed if photographing infants, when the flash should be no less than one meter (3.3 ft.) from the subject.

⚠ When using the viewfinder

When operating the mode dial and the zoom button with your eye to the viewfinder, care should be taken not to put your finger in your eye accidentally.

⚠ Avoid contact with liquid crystal

Should the monitor break, care should be taken to avoid injury due to broken glass and to prevent liquid crystal from the monitor touching the skin or entering the eyes or mouth.

CAUTIONS

✓ **Keep dry**

This product is not waterproof, and may malfunction if immersed in water or exposed to high levels of humidity. Rusting of the internal mechanism can cause irreparable damage.

✓ **Keep free of salt, sand, and dust**

After using your camera at the beach or seaside, wipe off any sand or salt with a lightly dampened cloth and then dry your camera thoroughly.

✓ **Do not touch the lens with your fingers**

The proper procedure for cleaning the lens is described in "Technical Notes: Caring for Your Camera."

✓ **Handle the lens and all moving parts with care**

Do not apply force to the lens or to the battery, card, or connector. These parts are especially susceptible to damage.

✓ **Turn the product off before removing the battery or unplugging the AC adapter**

Do not unplug the product or remove the battery while the product is on, or while images are being recorded or deleted from memory. Forcibly cutting power to the product in these circumstances could result in loss of data or in damage to the internal circuitry or memory. To prevent an accidental interruption of power, avoid carrying the product from one location to another while the AC adapter is connected.

✓ **Do not drop**

The product may malfunction if subjected to strong shocks or vibration.

✓ **Keep away from strong magnetic fields**

Do not use or store this device in the vicinity of equipment that generates strong electromagnetic radiation or magnetic fields. Strong static charges or the magnetic fields produced by equipment such as radio transmitters could interfere with the monitor, damage data stored on the memory card, or affect the product's internal circuitry.

✓ **Avoid sudden changes in temperature**

Sudden changes in temperature, such as occur when entering or leaving a heated building on a cold day, can cause condensation inside the device. To prevent condensation, place the device in a carrying case or a plastic bag before exposing it to sudden changes in temperature.

✓ **Notes on the Monitor**

- The monitor may contain a few pixels that are always lit or that do not light. This is a characteristic common to all TFT LCD monitors and does not indicate a malfunction. Images recorded with the product will not be affected.
- Images in the monitor may be difficult to see in a bright light.
- The monitor is lit by a fluorescent backlight. Should the monitor begin to dim or flicker, contact your Nikon service representative.
- Do not apply pressure to the monitor, as this could cause damage or malfunction. Dust or lint adhering to the monitor can be removed with a blower brush. Stains can be removed by rubbing the surface lightly with a soft cloth or chamois leather.
- Should the monitor break, care should be taken to avoid injury due to broken glass and to prevent the liquid crystal from the monitor touching the skin or entering the eyes or mouth.

✓ **Batteries**

- When you turn the device on, check the battery-level displayed in the monitor to determine whether the battery needs to be replaced. The battery needs to be replaced when the battery-level indicator appears.
- Ready a spare battery and keep it fully charged when taking pictures on important occasions. Depending on your location, you may find it difficult to purchase replacement batteries on short notice.

- On cold days, the capacity of batteries tends to decrease. Be sure the battery is fully charged before taking pictures outside in cold weather. Keep a spare battery in a warm place and exchange the two as necessary. Once warmed, a cold battery may recover some of its charge.
- Should the battery terminals become dirty, wipe them off with a clean, dry cloth before use.

✓ **Memory cards**

- Turn the power off before inserting or removing memory cards. Inserting or removing cards with the power on could render them unusable.
- Insert memory cards as shown in the illustration at right. Inserting cards upside down or backwards could damage the camera or the card.

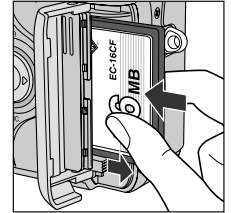

✓ **Storage**

- To prevent mold or mildew, store the camera in a dry, well-ventilated area. If you will not be using the product for a long period of time, remove the battery to prevent leakage and store the camera in a plastic bag containing a desiccant. Do not, however, store the camera case in a plastic bag, as this may cause the material to deteriorate. Note that desiccant gradually loses its capacity to absorb moisture and should be replaced at regular intervals.
- Do not store the camera with naphtha or camphor moth balls, close to equipment that produces strong magnetic fields, or in areas subject to extremes of temperature, for example near a space heater or in a closed vehicle on a hot day.
- To prevent mold or mildew, take the camera out of storage at least once a month. Turn the camera on and release the shutter a few times before putting the camera away again.
- Store the battery in a cool, dry place.

Notices

- No part of the manuals included with this product may be reproduced, transmitted, transcribed, stored in a retrieval system, or translated into any language in any form, by any means, without Nikon's prior written permission.
- Nikon reserves the right to change the specifications of the hardware and software described in these manuals at any time and without prior notice.
- Nikon will not be held liable for any damages resulting from the use of this product.
- While every effort has been made to ensure that the information in these manuals is accurate and complete, we would appreciate it were you to bring any errors or omissions to the attention of the Nikon representative in your area (address provided separately).

Notice for customers in Canada

CAUTION

This class B digital apparatus meets all requirements of the Canadian Interference Causing Equipment Regulations.

ATTENTION

Cet appareil numérique de la classe B respecte toutes les exigences du Règlement sur le matériel brouilleur du Canada.

Notice for customers in the U.S.A.

Federal Communications Commission (FCC) Radio Frequency Interference Statement

This equipment has been tested and found to comply with the limits for a Class B digital device, pursuant to Part 15 of the FCC rules. These limits are designed to provide reasonable protection against harmful interference in a residential installation. This equipment generates, uses, and can radiate radio frequency energy and, if not installed and used in accordance with the instructions, may cause harmful interference to radio communications. However, there is no guarantee that interference will not occur in a particular installation. If this equipment does cause harmful interference to radio or television reception, which can be determined by turning the equipment off and on, the user is encouraged to try to correct the interference by one or more of the following measures:

- Reorient or relocate the receiving antenna.
- Increase the separation between the equipment and receiver.
- Connect the equipment into an outlet on a circuit different from that to which the receiver is connected.
- Consult the dealer or an experienced radio/television technician for help.

CAUTIONS

Modifications

The FCC requires the user to be notified that any changes or modifications made to this device that are not expressly approved by Nikon Corporation may void the user's authority to operate the equipment.

Interface Cables

Use the interface cables sold or provided by Nikon for your equipment. Using other interface cables may exceed the limits of Class B Part 15 of the FCC rules.

Nikon Inc.,
1300 Walt Whitman Road, Melville, New York
11747-3064, U.S.A.
Tel.: 631-547-4200

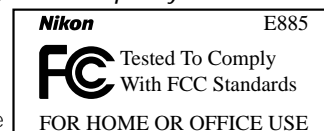

Notice Concerning Prohibition of Copying or Reproduction

Note that simply being in possession of material that has been digitally copied or reproduced by means of a scanner, digital camera or other device is punishable by law.

- **Items prohibited by law from being copied or reproduced**

Do not copy or reproduce paper money, coins, securities, government bonds, or local government bonds, even if such copies or reproductions are stamped "Sample."

The copying or reproduction of paper money, coins, or securities which are circulated in a foreign country is prohibited.

Unless the prior permission of the government has been obtained, the copying or reproduction of unused postage stamps or post cards issued by the government is prohibited.

The copying or reproduction of stamps issued by the government and of certified documents stipulated by law is prohibited.

- **Cautions on certain copies and reproductions**

The government has issued cautions on copies or reproductions of securities issued by private companies (shares, bills, checks, gift certificates, etc.), commuter passes, or coupon tickets, except when a minimum of necessary copies are to be provided for business use by a company. Also, do not copy or reproduce passports issued by the government, licenses issued by public agencies and private groups, ID cards, and tickets, such as passes and meal coupons.

- **Comply with copyright notices**

The copying or reproduction of copyrighted creative works such as books, music, paintings, woodcut prints, maps, drawings, movies, and photographs is prohibited except when it is done for personal use at home or for similar restricted and non-commercial use.

Trademark Information

Apple, the Apple logo, Macintosh, Mac OS, Power Macintosh, PowerBook, and QuickTime are registered trademarks of Apple Computer, Inc. Finder, Macintosh PC Exchange, Power Mac, iMac, and iBook are trademarks of Apple Computer, Inc. IBM and IBM PC/AT are registered trademarks of International Business Machines Corporation. PowerPC is a trademark of International Business Machines Corporation, used under license. Microsoft is a registered trademark, and Windows, MS-Windows and Windows NT trademarks, of Microsoft Corporation. Internet Explorer is a product of Microsoft Corporation. Pentium and i486 are trademarks of Intel Corporation. Internet is a trademark of Digital Equipment Corporation. Netscape and Netscape Navigator are registered trademarks of Netscape Communications Corporation. CompactFlash is a trademark of SanDisk Corporation. Lexar Media is a trademark of Lexar Media Corporation. Adobe and Acrobat are registered trademarks of Adobe Systems Inc. Zip is a registered trademark of Iomega Corporation in the U.S. and other countries. All other trade names mentioned in this manual or the other documentation provided with your Nikon product are trademarks or registered trademarks of their respective holders.

A Note on Electronically Controlled Cameras

In extremely rare instances, unusual characters may appear in the monitor and the camera may stop functioning. In most cases, this phenomenon is caused by a strong external static charge. Turn the camera off, remove and replace the battery, and turn the camera on again. If you are using an AC adapter, disconnect and reconnect the adapter, and turn the camera on again. If the camera continues to malfunction after performing the above operation, contact retailer or Nikon representative. Note that performing the above operation may eliminate data not recorded to the CF memory card at the time the camera stopped functioning. Data already recorded to the CF memory card will not be affected.

Table of Contents

Product Documentation	3
For Your Safety	4-9
Notices	10-13

Introduction: Before You Begin17-39

Overview: About This Manual18-19

Getting to Know the COOLPIX885:

Where to Find It—Parts of the COOLPIX885.....	20-21
How to Use It—Camera Controls and Displays.....	22-29

Menu Guide: Using Camera Menus30-39

Viewing the Menus	31
Making a Selection	32
Accessing Multi-Page Menus	33
Index to Menu Options	34-39
The SET-UP Menu	34-35
The Shooting Menu	36-37
The Playback Menu	38-39

Tutorial: Getting Started41-73

First Steps: Getting Ready to Use Your Camera.....42-53

1. Attach the Camera Strap and Lens Cap	43
2. Insert the Battery	44-46
3. Insert the CF Memory Card	47-49
4. Check the Battery Level.....	50
5. Choose a Language.....	51
6. Set the Date and Time.....	52-53

Taking Pictures.....54-67

1. Ready the Camera (AUTO Mode)	55-56
2. Adjust Camera Settings (Optional).....	57
3. Compose the Picture.....	58-59
4. Focus and Shoot	60-61
5. Check the Results.....	62
6. Turn the Camera Off.....	62
7. Assisted Creative Photography: Select Scene Mode	63-67

Reviewing and Deleting68-73

Quick Review	70
Full-Screen Review.....	71
Thumbnail Review	72
Selecting images for transfer to the computer.....	73

Where Do I Go from Here?: Doing More with Your Digital Camera75-85

How Do I Send Pictures to My Friends and Family?:

Distributing Photos by E-Mail and the Web	76-81
Creating Small Picture Files for E-Mail and the Web.....	76-79
Distributing Images Electronically	80-81

How Do I Make Prints?: From Data to Paper.....82-84

Taking Pictures for Printing	82
Digital Print-Order Format (DPOF)	83
Printing from Removable Media.....	84

How Do I Keep Track of My Photos?:

Using Image Database Software	85
-------------------------------------	----

Reference: The Details87-205

Beyond Point-and-Shoot.....88-101

Creative Photography: Choosing a Mode	88-89
Framing Pictures: Optical and Digital Zoom	90-91
Focusing Near and Far: Focus Mode Button	92-94
Delaying Shutter Release: Self-Timer Mode	95-96
Throwing Light on Your Subject: The Flash Button.....	97-99
Bright, Dark, and High-Contrast Subjects: Exposure Compensation	100
Choosing a Focus Area: Manual Focus-Area Selection	101

Camera Setup: The SETUP Menu.....102-125

To View the SET-UP Menu	102
Making Effective Use of Memory: Image Size and Quality Menu	103-107
Organizing Your Pictures: The Folders Menu.....	108-112
Monitor Options	113-114
Conserving Battery Power: The Auto Off Menu	115
File Numbering: The Seq. Number Menu	116
CF Card Format	117
Storing Camera Settings: The Controls Menu	118
Confirming Shutter Release: The Shot Confirm Lamp Menu.....	119
Photo Information and Transfer Setting: The Pic Data/Transfer Menu.....	120-121
The Date Menu	122
Choosing a Video Standard: The Video Mode Menu.....	122
The Language Menu	123
Restoring Default Settings: The Reset All Menu	124-125

Advanced Photography: CSM Shooting Mode	126-154
Adjusting Exposure Manually: Manual Exposure Mode	127-129
Reacting Faster to Light: Sensitivity (ISO Equivalency)	130-131
Focusing at a Preset Distance: Manual Focus	132-133
Using CSM Shooting Menu Options	134-154
Keeping Colors True: The White Balance Menu	135-136
Measuring Light: The Metering Menu	137-138
Taking Pictures in a Sequence: The Continuous Menu	139-140
Getting Sharper Pictures: The BSS (Best-Shot Selector) Menu	141
Contrast, Brightness and Image Type: The Image Adjustment Menu	142-143
Making Edges More Distinct: The Image Sharpening Menu	144
Setting for Optional Lens Converters: The Lens Menu	145-146
Modifying Sensitivity from a Menu: The Sensitivity Menu	147
Exposure Options	148-149
Focus Options	150-151
Auto Bracketing	152-153
Noise Reduction	154
Playing Images Back: Playback Mode	155-177
Basic Playback	156-162
The Playback Menu	163-175
Television Playback: Connecting Your Camera to a Video Device	176-177
Connections: Your Camera and Your Computer	178-186
Before Your Begin: Installing Nikon View	179-180
Getting Connected: Connecting to Your Computer	181-184
Reading Pictures from CF Memory Cards	185-186
Technical Notes: Camera Care, Options and Resources	187-205
Caring for Your Camera	188
Optional Accessories	189
Web Resources	190
Troubleshooting	191-193
Error Messages	194-196
Specifications	197-201
Index	202-205

Introduction

This chapter is divided into the following sections:

.....

Overview

Read this section for a description of how this manual is organized and for an explanation of the symbols and conventions used.

Parts of the COOLPIX885

Bookmark this section and refer to it as you read through the manual for information on the names and functions of camera parts.

Menu Guide

Refer to this section for instructions on using the menus that control some aspects of camera operation. This section also contains an index of menu options.

Before You Begin

Overview
pp. 18-19

Parts of the
COOLPIX885
pp. 20-33

Menu Guide
pp. 34-39

Thank you for your purchase of a COOLPIX885 digital camera. This manual has been written to help you enjoy taking digital pictures with your COOLPIX885. As you read through it, you will find explanations not only of how the camera works but also of why certain features have been included, and how they may be used to take pictures in many different situations.

The Introduction (this section) provides a quick overview of camera parts and menus that can be referred to later as you read through the remainder of the manual.

The Introduction is followed by a "Tutorial" that gives you enough information for simple "point-and-shoot" photography when you first start using your camera. This section may be all you need to read if you want to take advantage of the simplicity and immediacy of digital photography.

Once you have taken a few pictures, "Where Do I Go from Here?" outlines how to send copies to your friends and relatives by e-mail, how to order prints using digital "print orders" that you create with the camera, and how to keep track of your photos using image database software. It also provides some tips on how to take pictures for electronic distribution and for printing on a personal color printer.

Finally, the "Reference" section provides a comprehensive guide to all aspects of digital photography with the COOLPIX885, including creative photography in the camera's custom shooting modes, flash and close-up photography, taking movies, and manual control of exposure, tone, and sharpness. The "Reference" section also includes information on caring for your camera, troubleshooting, and optional accessories.

Life-Long Learning

As part of Nikon's "Life-Long Learning" commitment to ongoing product support and education, continually-updated information is available on-line at the following sites:

- For users in the U.S.A.: <http://www.nikonusa.com/>
- For users in Europe: <http://www.nikon-euro.com/>
- For users in Asia, Oceania, the Middle East, and Africa:
<http://www.nikon-asia.com/>

Visit these sites to keep up-to-date with the latest product information, tips, answers to frequently-asked questions (FAQs), and general advice on digital imaging and photography. Additional information may be available from the Nikon representative in your area. See the URL below for contact information:

<http://www.nikon-image.com/eng/>

Getting to Know the COOLPIX885

The Parts of the Camera and Their Functions







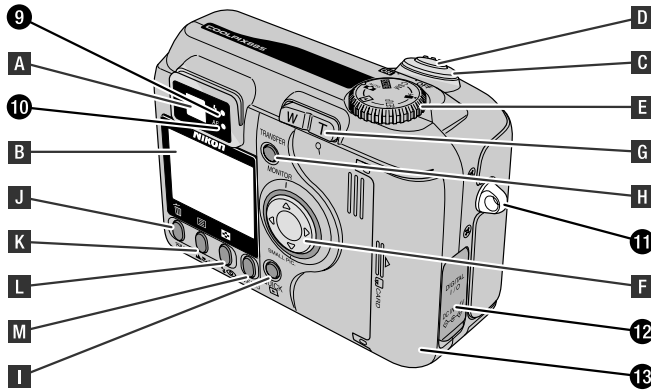
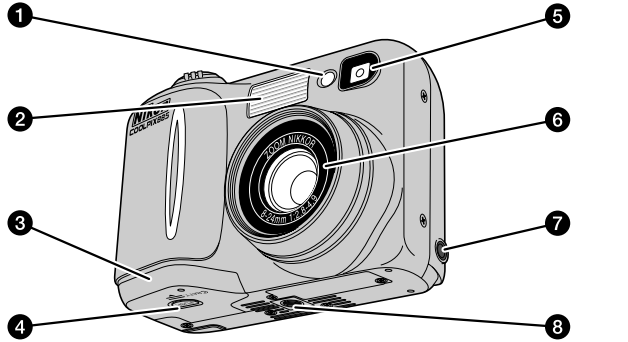

Take a few moments to familiarize yourself with camera controls and displays. You may find it helpful to bookmark this section and refer to it as you read through the rest of the manual.

Where to Find It—Parts of the COOLPIX885

The parts of the camera are identified below. For more information on the function of each part, refer to the page number that follows it.



The functions of the controls and displays that are labeled with a letter of the alphabet are outlined in the following section.

1 Red-eye reduction/Self-timer lamp.....	p. 98/95
2 Built-in Speedlight.....	p. 97
3 Battery chamber cover.....	p. 44
4 Battery chamber cover latch.....	p. 44
5 Viewfinder.....	p. 58
6 Lens.....	p. 197
7 Video output connector.....	p. 176
8 Tripod socket.....	
9 Red light.....	p. 22
10 Green light.....	p. 22
11 Camera strap eyelet.....	p. 43
12 DC-in connector/USB connector cover.....	p. 46/176
13 Memory card slot cover.....	p. 47
A Viewfinder.....	p. 22
B Monitor.....	p. 23
C Power switch.....	p. 24
D Shutter release button.....	p. 24
E Mode dial.....	p. 25
F Multi selector.....	p. 26
G Zoom button.....	p. 27
H TRANSFER button.....	p. 27
I QUICK  button.....	p. 28
J  button.....	p. 28
K     button.....	p. 29
L    button.....	p. 29
M MENU button.....	p. 29

How to Use It—Camera Controls and Displays

A The Viewfinder

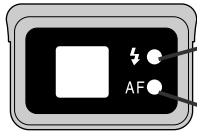

Red light
Green light

Pictures can be framed in the viewfinder or in the monitor. Note that when your subject is within 1.5 m (4.9 ft.) of the camera, the final picture will differ slightly from the image seen in the viewfinder. Use the monitor when your subject is close to the camera.

The two lights next to the viewfinder provide a guide to camera status while you frame your picture.

Light		Meaning
Red Light (Flash-ready light)	On	Flash (Speedlight) will fire when picture is taken.
	Flashes	Flash (Speedlight) charging (p. 99).
	Off	Flash (Speedlight) not required or flash set to "off".
Green Light (Autofocus light)	On	Subject in focus.
	Flashes rapidly	Camera unable to focus on subject. Use focus lock (p. 61).
	Flashes normally	Camera recording image(s) to CF memory card. Do not eject card or remove or disconnect power source while green light is blinking.
	Flashes slowly	Digital zoom (p. 90) in effect. Use the Monitor.

B Monitor

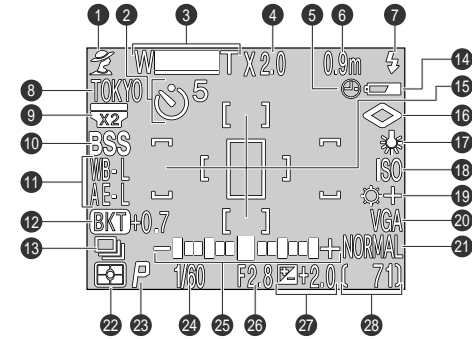

Like the viewfinder, the monitor can be used to frame pictures. During shooting, the monitor shows the view through the camera lens together with icons indicating the status of various camera settings. The monitor is also used to display pictures during quick review (p. 70) and playback (p. 155).

In the shooting modes, the following indicators appear in the monitor.

- | | |
|---|---|
| 1 Scene.....p. 63 | 15 Spot exposure metering area/
Focus area.....p. 137/101 |
| 2 Self-timer.....p. 95 | 16 Image sharpening.....p. 144 |
| 3 Zoom.....p. 90 | 17 White balance.....p. 135 |
| 4 Digital zoom.....p. 90 | 18 Sensitivity (ISO equivalency).....p. 130 |
| 5 "Date not set" icon*1.....p. 52 | 19 Image adjustment/Black-and-white
.....p. 142 |
| 6 Manual focus distance.....p. 132 | 20 Image size.....p. 106 |
| 7 Flash mode.....p. 98 | 21 Image quality.....p. 104 |
| 8 Current Folder name*2.....p. 108 | 22 Metering method.....p. 137 |
| 9 Lens converter setting.....p. 145 | 23 Exposure mode.....p. 148 |
| 10 Best Shot Selector.....p. 141 | 24 Shutter speed.....p. 128 |
| 11 Exposure lock (Auto exposure lock/
White balance lock).....p. 148 | 25 Exposure display (manual exposure
mode).....p. 128 |
| 12 Exposure bracketing/White balance
bracketing.....p. 152 | 26 Aperture.....p. 127 |
| 13 Continuous setting.....p. 139 | 27 Exposure Compensation.....p. 100 |
| 14 Battery level indicator*3.....p. 50 | 28 Number of exposures remaining/
Movie duration.....p. 56/160 |

*1 Blinks if date/time has not been set.

*2 Not displayed when folder name is set to NIKON.

*3 Only displayed when battery power drops below a certain level.

C Power switch

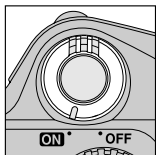

The power switch turns the camera on and off. When the camera is turned on, the green light next to the viewfinder will turn on and the lens will zoom out in shooting mode. The lens retracts automatically when the camera is turned off.

D Shutter release button



The COOLPIX885 has a two-stage shutter release button.

Press the shutter release button halfway to focus ①. The green light next to the viewfinder will come on when the camera has focused on the subject. Focus will remain fixed while the button is held in this position (focus lock).

Press the shutter release button all the way down to take a picture ②.

E The Mode dial

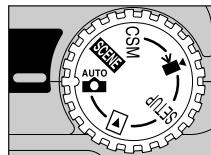

Icon	Mode	Description	Page
	Auto	An automatic mode for simple, "point-and-shoot" snapshot pictures.	55
	Scene	This mode offers a choice of settings for specific scenes. Each of the 12 modes optimizes the camera for scenes of specific type, such as sunsets or portraits.	63
	Custom	Gives you complete control of all settings, including exposure mode.	126
	Movie	In this mode, you can record silent movies up to forty seconds in length.	89
	Setup	This mode lets you configure the camera's basic settings such as date, time etc.	102
	Playback	This mode is used to play back and delete pictures.	155

F The Multi selector

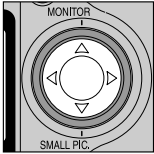

The Multi selector is used for a variety of operations: to compose pictures, to scroll through images in quickly review and playback, and to navigate through the camera menus and control the display in the Monitor.

Position	Situation	Function	Page
	Taking pictures without focus area indicators	Turn the Monitor on and off; hide and display camera settings.	158
	Full-frame playback/full-screen review		
	Taking pictures with focus area indicators on*	Shift the focus area up.	101
	Using the menus	Move the highlight bar up.	32
	Taking pictures with focus area indicators on*	Shift the focus area left.	101
	Full-frame playback/quick review/full-screen review	View the picture including small pictures recorded before the current picture.	156 70 71
	Using the menus	Return to the previous menu.	32
		Taking pictures with focus area indicators on*	Shift the focus area right.
Full-frame playback/quick review/full-screen review		View the picture including small pictures recorded after the current picture.	156 70 71
Using the menus		Make a selection.	32

Position	Situation	Function	Page
	Taking pictures with focus area indicators on*	Shift the focus area down.	101
	Full-frame playback/full-screen review	Create a small-sized picture file.	76
	Using the menu	Move highlight bar down.	32

* Focus area indicators are displayed when "Manual" option is selected in "Focus Options > AF Area Mode" in CSM shooting menu, or when Portrait (p. 65) or Close Up (p. 67) is selected in Scene mode.

G The Zoom button

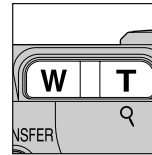

Use the zoom button to frame pictures. Press **W** to zoom out, increasing the area visible in the final picture. Press **T** to zoom in, enlarging small or distant objects to fill the frame (p. 90).

When an image is being played back full screen, press **T** (Q) to zoom in on that image. Press **W** to cancel zoom (p. 161).

H The TRANSFER button

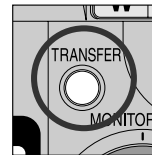



The transfer (**TRANSFER**) button is used to select images for transfer and to transfer selected images from the camera to a computer running Nikon View.

When images are played back on the camera monitor, the **TRANSFER** button is used to select movies and pictures for transfer to a computer at a later date (p. 73).

When the camera is connected to a computer running Nikon View, pressing the **TRANSFER** button copies all selected images to the computer (p. 80).

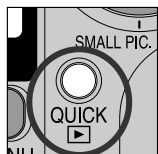



I The QUICK button



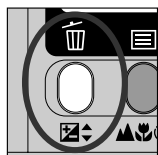













When taking pictures, the quick review (**QUICK** ) button is used to view the results of earlier pictures while setting up the next shot (p. 70).

J button







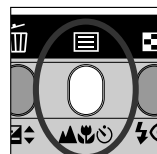

The functions controlled by the      button depend on the operating mode and on the combination of buttons used.

Function	Mode	Operation	Page
Exposure compensation	AUTO, SCENE, CSM (exposure mode P only)	  + 	100
Shutter speed	CSM (exposure mode M only)	  + 	128
Aperture	CSM (exposure mode M only)	  + 	127
Sensitivity (ISO equivalency)	CSM	  + 	130
Single-image deletion	 , full-screen review or thumbnail review mode in AUTO, SCENE or CSM	 Press	71-72, 156, 162

K button





The functions controlled by the    button depend on the operating mode and on the combination of buttons used.

Function	Mode	Operation	Page
Focus mode	AUTO, SCENE, CSM	  Press	92
Manual focus distance	CSM	  + 	132
Photo-information display	 (Playback)	 Press	158

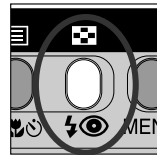
L button



When taking pictures, the flash mode () button controls the built-in Speedlight (p. 97).

In full-frame playback or full-screen review, pressing this button displays the images stored on the CF memory card as small (thumbnail) preview , allowing you to choose images for playback or deletion from a menu of nine or four (p. 72, 162).

M The MENU button

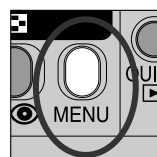

Press the MENU button to display or hide the menu for the current operating mode except in **AUTO** or  movie mode, or to display the second page of a two-page menu (p. 31).

Changes to some settings can be made with the help of menus that appear in the monitor. The options available depend on the operating mode. No menu is available in AUTO and movie mode.

Mode	Menu	Description	Page
SETUP	SET-UP	Basic camera setup (image quality and size setting, formatting CF memory cards, setting the time and date, etc.)	102
CSM (Custom)	SHOOTING MENU	Advanced shooting options (white balance, metering, etc.)	134
SCENE	SCENE	Select the scene from a menu of 12 creative shooting situations.	63
	PLAYBACK MENU	Playback options such as deleting selected pictures or selecting images for transfer to your computer, etc.	163

Viewing the Menus

When the camera is on, the menu for the current operating mode except AUTO and  movie can be displayed by pressing the **MENU** button.

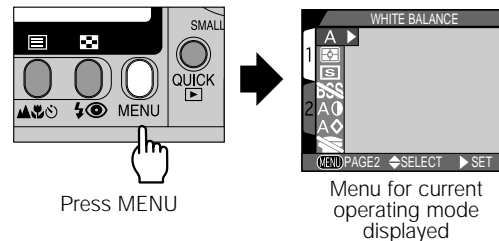

If "**MENU PAGE2**" appears at the lower left corner of the menu, pressing the **MENU** button again will display the menu's second page. When "**MENU OFF**" is displayed, pressing the **MENU** button returns you to shooting or playback mode.

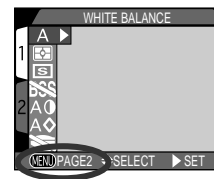

Making a Selection

Use the Multi selector to make a selection.

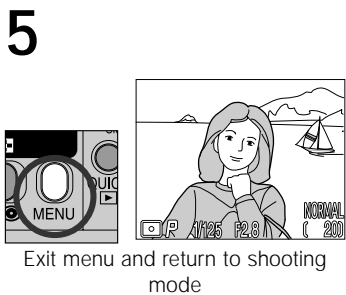
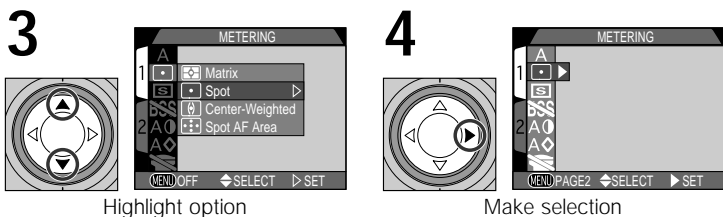
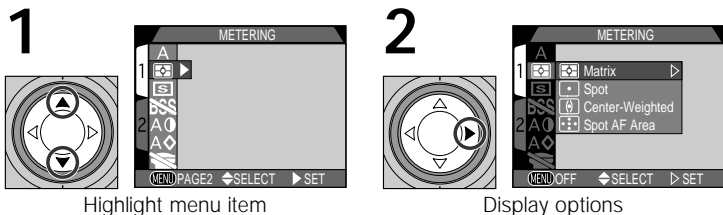

- To return to the previous menu after making a selection, press the Multi selector to the left or right.
- The view through the lens is visible behind the CSM and SCENE menus. To take pictures while the menu is displayed, press the shutter-release button.

Accessing Multi-Page Menus

To move between pages in a multi-page menu:

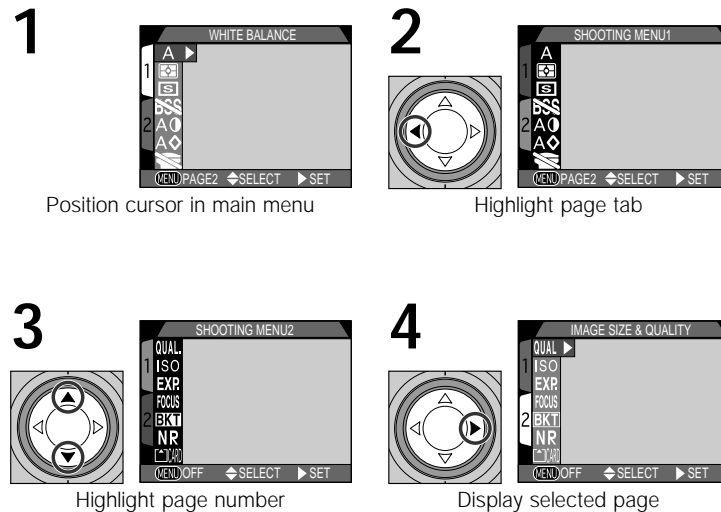

- You can also jump from the first page to the second page of a multi-page menu by pressing the MENU button once.

Index to Menu Options

SET-UP 1

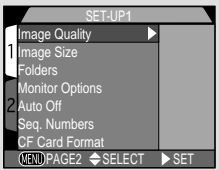

Set Mode dial to SETUP.



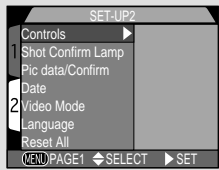

SET-UP 2

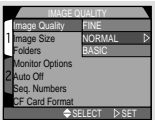
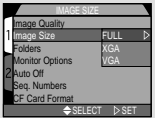
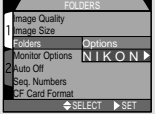
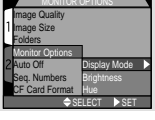
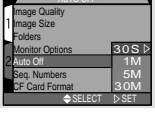
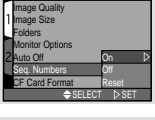
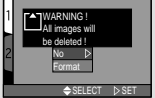

Press the MENU button or Multi selector to switch between SET-UP menu 1 and 2.

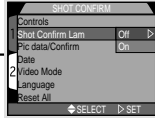
SET-UP menu contains two pages of options.

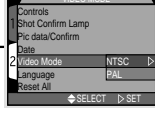
	<p>Image Quality Select the image quality (except HI) used for all modes (p. 103)</p>	<p>FINE NORMAL BASIC</p>	
	<p>Image Size Choose image size used for all modes (p. 103)</p>	<p>FULL XGA VGA</p>	
	<p>Folders Create, rename or delete folders; choose folder to record to (p. 108)</p>	<p>Options NIKON (Folder name)</p>	<p>New/Rename/ Delete</p>
	<p>Monitor Options Adjust monitor brightness and hue (p. 113)</p>	<p>Display Mode Brightness Hue</p>	<p>Monitor On/Review Only/ Preview Only/Monitor Off (5 levels) (11 levels)</p>
	<p>Auto Off Set time delay for Auto-Off function (p. 115)</p>	<p>30 S 1 M 5 M 30 M</p>	
	<p>Seq. Numbers Reset Seq. Number function; turn file numbering on or off (p. 116)</p>	<p>On Off Reset</p>	
	<p>CF Card Format Format CF memory card (p. 117)</p>	<p>WARNING! All images will be deleted!</p>	<p>No/Format</p>

	<p>Controls Set camera to "remember" settings in effect when camera is turned off (p. 118)</p>	<p>save save save Digital Zoom</p>	<p>On/Off On/Off On/Off On/Off</p>
	<p>Shot Confirm Lamp Control visual shutter release confirmation (p. 119)</p>	<p>Off On</p>	
	<p>Pic Data/Transfer Save photo information in text format; turn transfer marking on or off (p. 120)</p>	<p>info.txt Auto Transfer</p>	<p>On/Off On/Off</p>
	<p>Date Set date and time (p. 122)</p>	<p>Year/Month/Day/Hour/ Minute Display order</p>	
	<p>Video Mode Select the video standard to use for playback on TV (p. 122)</p>	<p>NTSC PAL</p>	
	<p>Language Select language for menu and message display (p. 123)</p>	<p>D E F J S</p>	
	<p>Reset All Reset all settings to default values (p. 124)</p>	<p>No Yes</p>	

Shooting Menu 1 (CSM)

Set Mode dial to CSM. Press the MENU button to select.

Shooting menu contains two pages of options.

Shooting Menu 2 (CSM)

Press the MENU button or Multi selector to switch between the Shooting menus.

<p>White Balance Select the white balance to match lighting conditions (p. 135)</p>	<ul style="list-style-type: none"> A Auto White Bal Preset Fine Incandescent Fluorescent Cloudy Speedlight
<p>Metering Select metering mode (p. 137)</p>	<ul style="list-style-type: none"> Matrix Spot Center-Weighted Spot AF Area
<p>Continuous Select Shooting mode (p. 139)</p>	<ul style="list-style-type: none"> Single Continuous Multi-shot 16 VGA Sequence Ultra HS
<p>Best-Shot Selector Turn best shot selection on or off (p. 141)</p>	<ul style="list-style-type: none"> BSS Off BSS On
<p>Image Adjustment Adjust brightness or contrast of image (p. 142)</p>	<ul style="list-style-type: none"> A AUTO Normal + More Contrast - Less Contrast Lighten Image Darken Image Black & White
<p>Image Sharpening Select the level of image sharpening to be performed (p. 144)</p>	<ul style="list-style-type: none"> A AUTO High Normal Low Off
<p>Lens Select type of optional lens converter or Slide Copy Adapter (p. 145)</p>	<ul style="list-style-type: none"> Normal Wide Adapter Telephoto 1 Telephoto 2 Fisheye Slide Copy Adptr Fisheye 1 Slide Copy Adptr

<p>Image Quality and Size Set image quality and size used for all modes (p. 103)</p>	<ul style="list-style-type: none"> Image Quality Image Size 	<ul style="list-style-type: none"> HI/FINE/NORMAL/BASIC FULL/XGA/VGA
<p>Sensitivity Adjust sensitivity setting for current mode (mirrors setting made with button) (p. 147)</p>	<ul style="list-style-type: none"> AUTO 100 200 400 	
<p>Exposure Options Set exposure mode, turn AE Lock and Auto Bracketing on or off, set exposure compensation (p. 148)</p>	<ul style="list-style-type: none"> Exposure mode AE Lock EXP. +/- 	<ul style="list-style-type: none"> P/M Off/On/Reset +2.0 to -2.0
<p>Focus Options Select AF Area, change Autofocus mode, confirm focus, distance unit displayed (p. 150)</p>	<ul style="list-style-type: none"> AF Area Mode Auto-Focus Mode Focus Confirmation Distance Units 	<ul style="list-style-type: none"> Auto/Manual/Off Continuous AF/Single AF MF/On/Off m/ft
<p>Auto Bracketing Set Auto Bracketing (on or off) or White Balance Bracketing (p. 152)</p>	<ul style="list-style-type: none"> Off On WB Bracketing 	<ul style="list-style-type: none"> 3, ±0.3/3, ±0.7/3, ±1.0/5, ±0.3/5, ±0.7/5, ±1.0
<p>Noise Reduction Turn Noise Reduction on or off (p. 154)</p>	<ul style="list-style-type: none"> On Off 	
<p>CF Card Format Format CF memory card (p. 117)</p>	<ul style="list-style-type: none"> WARNING! All images will be deleted! 	<ul style="list-style-type: none"> No Format

Playback Menu 1

Set Mode dial to .
Press the MENU button to select.

Playback menu contains two pages of options.

Playback Menu 2

Press the MENU button or Multi selector to switch between the Playback menus.

	Delete Delete selected images using thumbnail display; delete all images or the settings of Print-order files (p. 164)	<ul style="list-style-type: none"> Selected Images All Images Print Set
	Folders Create, rename or delete folders; choose folder to record to (p. 167)	<ul style="list-style-type: none"> Options → New/Rename/Delete All Folders NIKON (Folder name)
	Slide Show Start slide show for images in a single folder; set frame interval from as 2, 3, 5 or 10 sec. (p. 168)	<ul style="list-style-type: none"> Start Frame Intvl → 2S/3S/5S/10S (Pause →)
	Protect Protect selected images from thumbnail display (p. 170)	(Select image and set Protect)
	Hide Image Hide selected images from thumbnail display (p. 171)	(Select image and set Hide Image)
	Print Set Select images for printing from thumbnail display (p. 172)	1 (Select image and set number of prints)

	Transfer Mark all pictures for transfer or remove marks from all pictures (p. 174)	<ul style="list-style-type: none"> All ON All OFF
	Small Pic. Set a Small Picture image size suitable for e-mail and Web distribution (p. 175)	<ul style="list-style-type: none"> 640 x 480 320 x 240 160 x 120 96 x 72
	Auto Off Set time delay for Auto-Off function (p. 115)	<ul style="list-style-type: none"> 30 S 1 M 5 M 30 M

Tutorial

Getting Started

First Steps
pp. 42-53

Taking Pictures
pp. 54-67

**Reviewing and
Deleting**
pp. 68-73

This chapter is divided into three sections:



First Steps

This section details the steps you will take before using your camera for the first time.

Taking Pictures

Read this section for a step-by-step guide to the basics of taking pictures with the COOLPIX885.

Reviewing and Deleting

Learn how to review and delete pictures while setting up your next shot.

Before using your camera for the first time, you will need to complete the steps shown below. Additional information on the topics covered in this section may be found on the pages listed in the rightmost column.

	Step	Page
Step 1	Attach the Camera Strap and Lens Cap	43
Step 2	Insert the Battery	44-46
Step 3	Insert the CF Memory Card Formatting the CF Memory Card	47-49
Step 4	Check the Battery Level	50
Step 5	Choose a Language	51
Step 6	Set the Date and Time	52-53

Step 1—Attach the Camera Strap and Lens Cap

Camera Strap

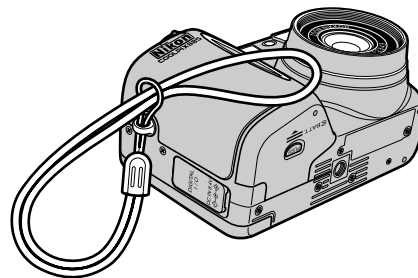

- Attach the strap as shown.

Lens cap

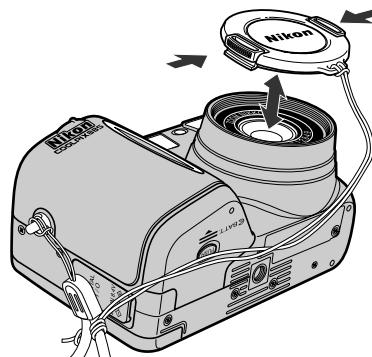

- Press the tabs on the lens cap to attach/detach it.
- We recommend attaching the lens cap to the strap loop with the supplied cord to prevent it from being misplaced.

Step 2—Insert the Battery

Your camera is powered by a single rechargeable Nikon EN-EL1 lithium-ion battery or a non-rechargeable 2CR5 (DL245) lithium battery. Note that either the Nikon EN-EL1 lithium-ion battery or 2CR5 (DL245) lithium battery may be supplied with your camera, depending on the area of purchase.

1 Turn the camera off

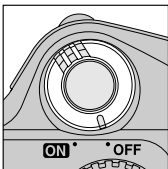

- If the camera is on a tripod, remove it from the tripod before proceeding to the next step.

2 Open the battery-chamber cover

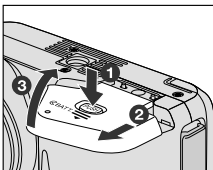

- Pressing the battery-chamber cover latch (1), slide the battery-chamber cover out (2) and flip it open (3).

3 Insert the battery

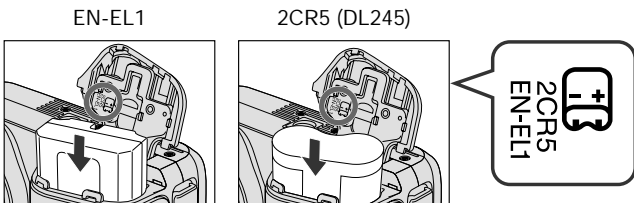

- Insert a rechargeable Nikon EN-EL1 lithium-ion battery or 2CR5 (DL245) lithium battery as shown.

4 Close the battery-chamber cover

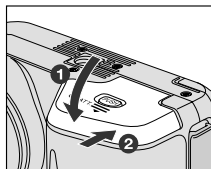

- Close the battery chamber cover (1) and slide it to the closed position (2). To prevent the battery being dislodged during operation, be sure that the battery chamber cover is properly latched.

Charge the rechargeable Nikon EN-EL1 lithium-ion battery

We recommend that you use the battery charger to charge the EN-EL1 battery before use since the EN-EL1 battery is not fully charged at shipment. Instructions for charging the battery may be found in the instruction manual supplied with the charger. Note that the 2CR5 (DL245) lithium battery is not rechargeable.

Read Battery Warnings

Read and follow all warnings and instructions supplied by the battery manufacturer.

Caution Regarding Battery Use

- In some cases the "WARNING!! BATTERY EXHAUSTED" message may not appear in the monitor if an exhausted battery is re-inserted into the camera.
- The rechargeable Nikon EN-EL1 lithium-ion battery should be removed and recharged as soon as the message "WARNING!! BATTERY EXHAUSTED" appears in the monitor. Turning the camera on and off with an exhausted battery in place may shorten the life of the battery.

Removing the Battery

The battery can be removed without affecting pictures stored on the CF memory card.

Alternative Power Sources

Although the COOLPIX885 can be used with non-rechargeable 2CR5 (DL245) lithium batteries, available at a variety of retail outlets, we recommend the rechargeable Nikon EN-EL1 Li-ion battery. This lithium-ion battery, for use exclusively with COOLPIX885, 775, 880, and 995 digital cameras, can be recharged in the exclusive battery charger for the EN-EL1. To power your camera continuously for extended playback or similar tasks, you can use the EH-21 (available separately), an AC adapter that doubles as a battery charger for the EN-EL1.

Connecting the camera to the AC adapter EH-21

The COOLPIX885 can be connected to your household mains electricity supply (100 AV) via the AC adapter EH-21. Connect the adapter's DC plug to the COOLPIX885 DC-in connector, then connect the adapter to the mains socket. When connecting the camera as described above, beware of the following points:

- Turn the camera off before disconnecting the DC plug from the camera.
- Do not plug any appliances other than the EH-21 AC adapter into the DC-in connector.
- The camera and the adapter may both become warm when connected for an extended period of time, but this does not indicate a malfunction.
- The EN-EL1 Li-ion battery cannot be recharged while inserted into the camera. It must be removed and placed in the AC adapter/battery charger.

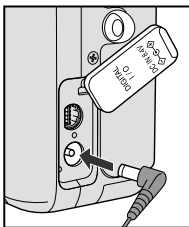

Step 3—Insert the CF Memory Card

In place of film, your Nikon digital camera uses CompactFlash™ (CF) memory cards to store pictures. This step provides instructions on inserting CF memory card.

1 Turn the camera off

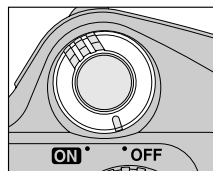

2 Insert the CF memory card

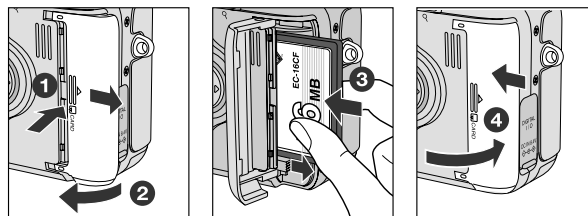

- Slide the card-slot cover out ① and flip it open ②. Hold the card with the arrow (s) facing towards you and insert it in the direction of the arrow ③, sliding it in until it is firmly in place and the eject button pops up. Close the card slot cover ④.

Removing CF Memory Cards

CF Memory cards can be removed without loss of data when the camera is off. To remove memory cards, turn the camera off and open the card-slot cover ①. Press the eject button to partially eject the card ② and then remove the card by hand.

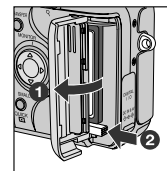

See p. 189 for more information on approved CF memory cards.

Formatting CF Memory Cards

While the CF memory card provided with your camera is formatted at shipment, other CF memory cards must be formatted before first use. To format a CF memory card:

1 Set the Mode dial to SETUP and turn camera on.

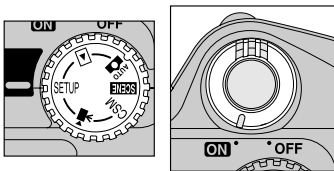

• CF memory cards can also be formatted in shooting menu 2 (CSM).

2 Highlight "CF Card Format".

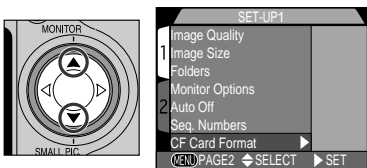

3 Confirmation dialog displayed

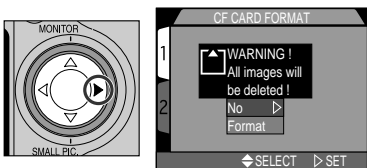

4 Highlight "Format"

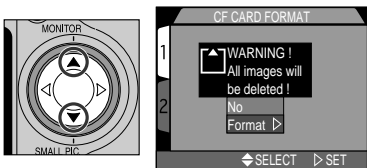

• To exit without formatting card, highlight "No" and press ►.

5 Press ► to start formatting

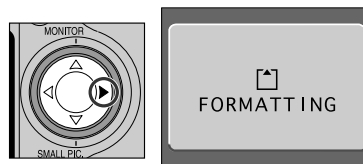

- Formatting begins immediately.
- While formatting is in progress, the message shown will be displayed.

During Formatting

Do not remove the CF memory card, remove the battery or unplug the AC adapter (available separately) while formatting is in progress.

Before Formatting

Formatting permanently deletes all data on the CF memory card. Be sure to transfer any images you would like to keep to a computer before formatting.

Step 4—Check the Battery Level

Before using the camera, check the battery level in the monitor to make sure that the battery is charged.

1 Turn the camera on

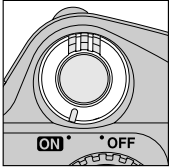

2 Check the battery level in the monitor

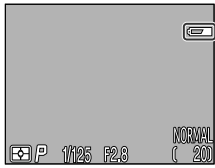

- When the battery is running low, a battery indicator appears in the monitor (if no icon appears, this indicates that the battery is fully charged). A  icon indicates that the battery should be recharged or replaced without delay. If the message “WARNING!! BATTERY EXHAUSTED” appears in the monitor, the battery is exhausted, and no pictures can be taken until the battery is replaced.

The Clock Battery

The camera's internal clock-calendar is powered by a separate, rechargeable power source, which is charged as necessary when the main battery is installed. If the camera has been stored for an extended period with the main battery removed, the clock may need to be reset. Once the main battery has been re-inserted, the clock's power source will recharge within a number of hours, during which time the main battery should be left in the camera.

Step 5—Choose a Language

Camera menus and messages can be displayed in your choice of German, English, French, Japanese and Spanish.

1

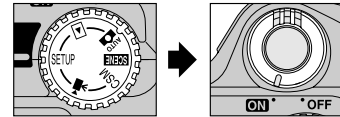

Set mode dial to SETUP and turn camera on

2

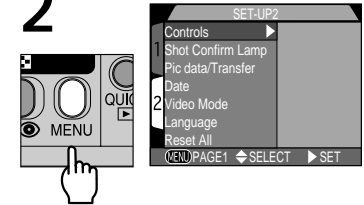

Press MENU button to display SET-UP 2 menu

3

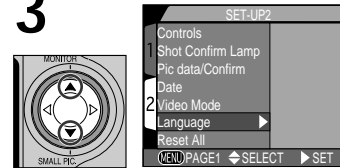

Highlight “Language”

4

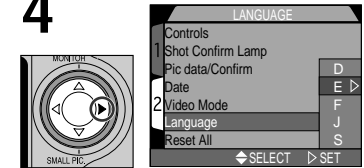

Display options

5

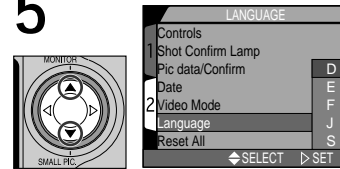

Choose a language from:

- D:** Deutsch (German)
- E:** English
- F:** Français (French)
- J:** Japanese
- S:** Español (Spanish)

6

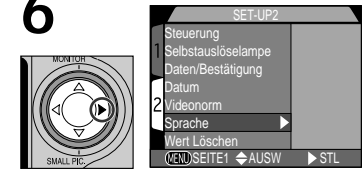

Press ► to set

Step 6—Set the Date and Time

Information on the time and date of recording is included with all pictures and movies taken with your Nikon digital camera. To set the camera's internal clock to the correct time and date:

1

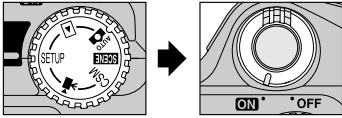

Set the mode dial to SETUP and turn camera on

- The appearance of the menu will vary depending on the language currently selected.

2

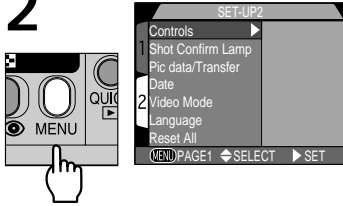

Press MENU button to display SET-UP 2 menu

3

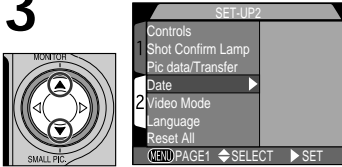

Highlight "Date"

4

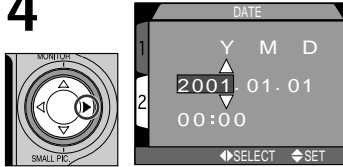

Display DATE menu

5

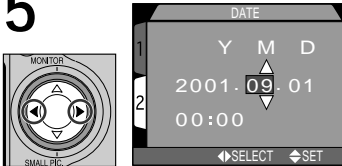

Highlight Year, Month, Day, hour or minute (the selected digit blinks in red)

6

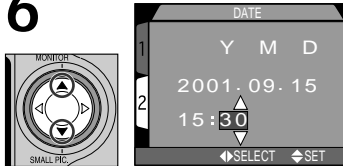

Edit selected item

- Repeat steps 5 and 6 until all items have been set.

7

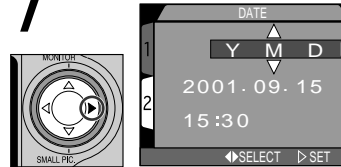

Highlight YMD

8

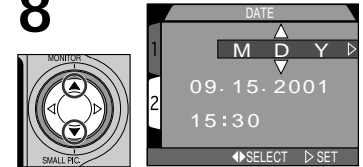

Choose order in which year, month and day will be displayed

9

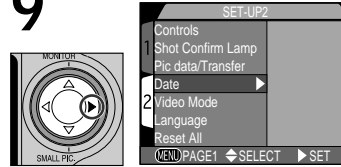

Press ► to save changes to settings and return to SET-UP menu.

Any pictures taken before the time and date have been set will have a time stamp of "0000.00.00 00:00." If the time and date have not been set, a flashing clock icon will be displayed in the top right corner of the monitor when the camera is in shooting mode.

This section details the basic steps involved in taking pictures in AUTO and SCENE modes. In these automatic, “point-and-shoot” modes, the majority of settings are controlled by the camera in response to lighting conditions and focus distance, producing the best possible results.

Step		Page
Step 1	Ready the Camera	55-56
Step 2	Adjust Camera Settings (Optional)	57
Step 3	Compose the Picture	58-59
Step 4	Focus and Shoot	60-61
Step 5	Check the Results	62
Step 6	Turn the Camera Off	62
Step 7	Assisted Creative Photography: Select Scene Mode	63-67

Step 1—Ready the Camera (Auto Mode)

Before using your camera, complete the following steps:

1 Remove the lens cap

- If you turn the camera on with the lens cap in place and the mode dial set to AUTO, SCENE, CSM or , an error message will appear in the monitor. To clear this message from the display, turn the camera off and remove the lens cap.

2 Turn the mode dial to

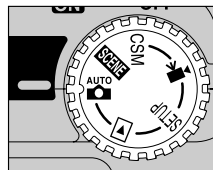

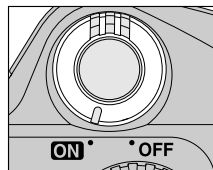

3 Turn the camera on

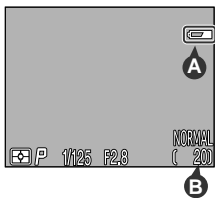

- The lens zooms out when the camera is turned on and the green light next to the viewfinder will turn on for a few seconds. After a short pause, the view through the lens and camera settings will appear in the monitor.

4 Check indicators in the monitor





- Before taking pictures, be sure that the battery power is sufficient and that enough memory is available on the memory card. If the battery is low, a  icon (A) will appear in the monitor, indicating that the battery should be recharged or replaced without delay. If the message "WARNING!! BATTERY EXHAUSTED" appears in the monitor, the battery is exhausted, and no pictures can be taken until the battery has been recharged or replaced (p. 44).

- The monitor also shows the number of exposures remaining, or in other words the number of photos that can be taken at current settings (B). When this number reaches zero, you will need to insert a new memory card or delete some pictures (p. 164) before more images can be recorded. It may be possible to record more pictures at a different image quality or size (p 103).

Step 2—Adjust Camera Settings (Optional)

In AUTO mode, you can use the buttons and menus to control the settings listed in the following table. The first time you use the camera, these settings will be set to the default values shown below. These settings are adequate for most situations, and the description in this section assumes that the defaults are used. For information on making changes to the settings listed below, refer to the page numbers in the rightmost column.

Setting	Default	Description	Control	Page
Focus mode/ self-timer	Autofocus	Camera focuses automatically at distances over 30 cm/1 ft. (widest angle) or 60 cm/2 ft. (telephoto); self-timer off		92-94 95-96
Flash mode	Auto	Flash fires automatically when lighting is poor		97-99
Image quality	NORMAL	Images compressed for a balance between quality and file size that is ideal for snapshots	SET-UP menu	103-105
Image size	FULL	Images are 2048 x 1536 pixels. When image quality is set to NORMAL and image size to FULL, about twenty images can be stored on one 16 MB CF memory card	SET-UP menu	103 106 107

Step 3— Compose the Picture

After adjusting camera settings, you are ready to frame your picture.

1 Ready the camera.

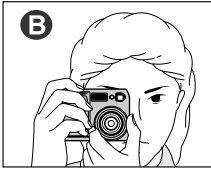
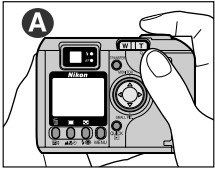

- To prevent blurred pictures caused by unsteady hands (camera shake), hold the camera steadily in both hands. Pictures can be framed in the monitor (A) or viewfinder (B).

2 Frame your subject.



Zoom out Zoom in

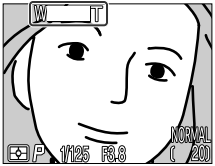

Indicator in monitor displays amount of zoom while either **W** or **T** is pressed.

- Frame your subject using the zoom button. Press the **W** to zoom out from your subject, increasing the area visible in the frame. Press the **T** to zoom in on your subject so that it fills a larger area of the frame.
- When the camera is zoomed all the way in to the **T** (Telephoto) side of the zoom indicator, holding the **T** down activates digital zoom, which can be used to magnify your subject even further (p. 90).

Don't Block the Shot

To avoid dark or partially obscured pictures, keep your fingers and other objects away from the lens and flash window.

Move That Camera!

Although zoom is a useful tool for composing pictures, remember that original compositions can be created just by moving the camera to another position. If you have time, try framing your subject from a number of different angles—including from below and above—to find the one that produces the best shot.

Monitor or Viewfinder?

Use the monitor to confirm camera settings at a glance while at the same time viewing an image that shows how the final picture will appear. This is particularly important when the image in the viewfinder does not accurately reflect what will appear in the final picture, for example when:

- macro close-up is used (p. 93)
- your subject is within 1.5 m (4.9 ft.) of the camera
- you are using digital zoom (p. 90)
- you are using an optional lens converter for wide-angle or telephoto photography (p. 145)

Using the viewfinder allows you to save power by turning the monitor off (see below). The viewfinder can also be used when bright ambient lighting conditions make the display in the monitor difficult to see.

Controlling the Monitor

The ▲ on the Multi selector controls the monitor display in AUTO, SCENE, CSM and ► mode. Press ▲ to cycle through monitor settings as shown at below.

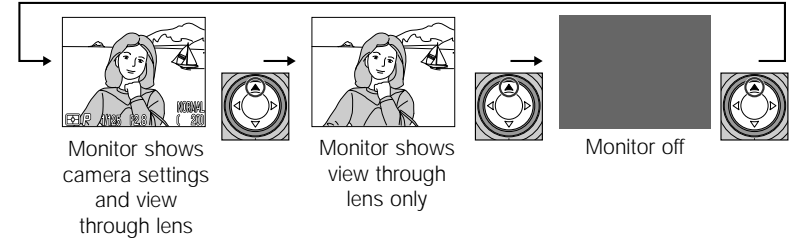

Step 4—Focus and Shoot

1 Focus

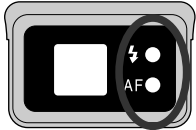
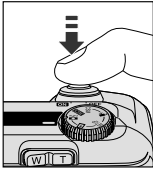

- In AUTO mode, the camera focuses on the subject in the center of the frame. To focus on the subject, press the shutter release button halfway. Check the status of the green (autofocus) and red (flash) lights next to the viewfinder.

Light		Meaning
Red Light (Flash light)	On	Flash will fire when picture is taken.
	Flashing	Flash charging. Remove finger briefly from shutter release button, then try again.
	Off	Flash not required or flash set to "off".
Green Light (Autofocus light)	On	Subject in focus.
	Flashing rapidly	Camera unable to focus on subject. Use focus lock to focus on another subject at the same distance, then recompose your picture.

2 Take the picture

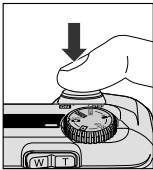

- To take a picture, press the shutter release button all the way down.

Focusing on an Off-Center Subject: Focus Lock

Depending on the effect you want to achieve, your subject may not be at the center of the final composition. In AUTO and all SCENE modes except Portrait and Close Up (p. 65, 67), the camera automatically focuses on the subject at the center of the frame. If your subject is not located at the center of the frame when the shutter release button is pressed halfway, the camera will focus on the background and the main subject may not be in focus. Focus lock is used to focus first on your subject, then adjust the composition before taking the picture.

1 Focus

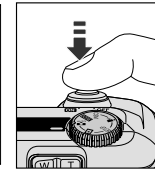
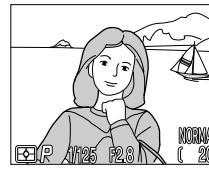

- Position the subject in the center of the frame and press the shutter release button halfway.

2 Check the green light

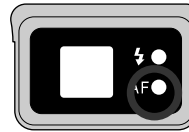

- With the shutter release button pressed halfway, check that the green (autofocus) light next to the viewfinder glows steadily, indicating that the subject is in focus. Focus will remain locked while the shutter release button is pressed halfway.

3 Recompose the picture and shoot

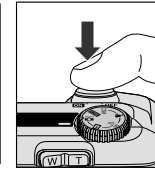
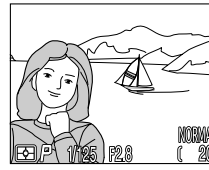

- Keeping the shutter release button pressed halfway, recompose your picture. Press the shutter release button the rest of the way down to shoot.

Do not change the distance between the camera and your subject while focus lock is in effect. If your subject moves, remove your finger from the shutter release button and focus again at the new distance.

Step 5—Check the Results



After each shot, the green light will blink as the picture is recorded to the CF memory card. If the monitor is on, the shot you have just taken will be displayed briefly in the monitor. Any additional shots you take while earlier pictures are being saved will be stored in a temporary memory buffer before being saved to the CF memory card. Pictures can be taken until the buffer is full (the buffer can hold about eight full-sized, normal-quality images). When the buffer is full, an hourglass icon (⌚) will be displayed and the shutter release will be disabled. Additional pictures can be taken as soon as enough memory is available in the buffer and the ⌚ icon is no longer displayed.

During Recording

While pictures are recorded to the CF memory card, the green light will blink. Do not eject the CF memory card, or remove or disconnect the power source until the light has stopped blinking. Removing the card or cutting power in these circumstances could result in loss of data.

Step 6—Turn the Camera Off

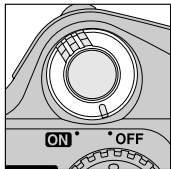

When you have finished using the camera, turn the camera off to save battery power.

Step 7—Assisted Creative Photography: Select Scene Mode

Although the AUTO mode is suited to a wide variety of situations, some compositions call for special combinations of settings. In SCENE mode, you select the scene from a menu of creative shooting situations, and the camera automatically adjusts settings to produce the best possible results.

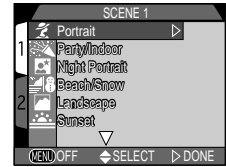

Shooting in Scene Mode

1

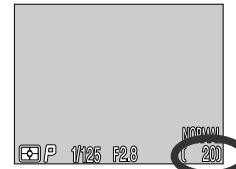
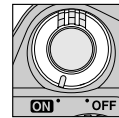

Turn the power switch on and check the number of available exposures

2

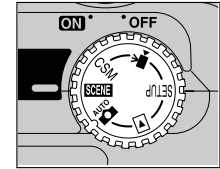

Turn the mode dial to SCENE

3

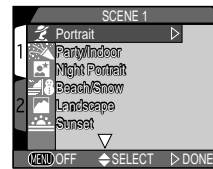
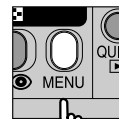

Press the MENU button to display the SCENE mode menu

4

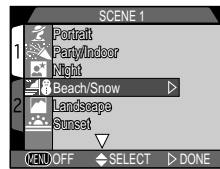
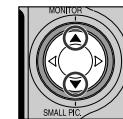

Press ▲/▼ to highlight the desired composition type

5

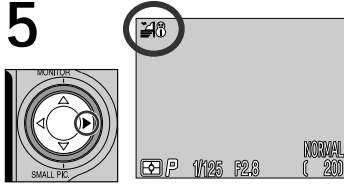

Press **▶** to make the selection and return to shooting mode

- The selected scene mode icon is displayed on the monitor.

7 Focus and shoot.

- Focus the camera and take the shot, as described on p. 60-61. Depending on the scene selected, you may be able to select the focus area manually, allowing you to focus on an off-center subject without using focus lock.

Note on SCENE mode

- Do not use SCENE mode when taking pictures that you plan to retouch on a computer.
- Depending on the subject, SCENE mode setting may not always produce the desired results. If you are dissatisfied with the results in SCENE mode, try using AUTO mode instead.
- In the SCENE mode, the Noise Reduction function (p. 154), which can be used to minimize the effect of noise on the recorded image, is automatically activated when the shutter speed is slower than 1/4 sec. When the Noise Reduction function is on, the time taken to save a picture to the CF memory card is approximately doubled.

When you press the MENU button to display the SCENE mode menu, the most-recently selected setting will be highlighted. Press the MENU button a second time to exit the menu.

6 Adjust camera settings

- Depending on the scene selected, you may be able to adjust flash and focus mode settings (see p. 65-67 for restrictions).
- Image quality and size can be adjusted from the SETUP menu (p. 103).

SCENE mode menu

 **Portrait:** Use for portraits. Main subject stands out clearly and background details are softened, lending composition sense of depth. Degree to which background details are softened depends on amount of light available.
Focus mode: Autofocus and autofocus + self-timer can be selected.

Focus area: The AF-area mode is set to **Manual**, so you can select the focus area with the Multi selector (p. 101).

 **Party/Indoor:** Use for indoor shots that include details of background behind main subject, or for shots taken by candlelight.

Flash mode: Auto with Red-Eye Reduction/Slow Sync.

Focus mode: Autofocus and autofocus + self-timer can be selected.

* In some situations slow shutter speed is selected. To avoid camera shake, make sure to hold the camera steady or use a tripod.

 **Night Portrait:** Use for pictures that provide a natural balance between the main subject and the background when taking portraits against a backdrop of night-time scenery.

Flash mode: Auto with Red-Eye Reduction/Slow Sync.

Focus mode: Autofocus and autofocus + self-timer can be selected.

* In some situations, a slow shutter speed is selected. To avoid camera shake, make sure to hold the camera steady or use a tripod.

 **Beach/Snow:** Vividly captures the brightness of such subjects as snowy fields, beaches, or sunlit expanses of water.

Flash mode: Any mode can be selected.

Focus mode: Any mode can be selected.





Landscape: Use for vivid landscape photos that enhance outlines, colors, and contrast in such subjects as skylscapes and forests.

Flash mode: Flash Cancel

Focus mode: Infinity and infinity + self-timer can be selected

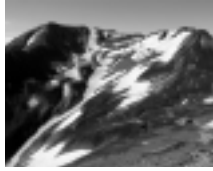

Sunset: Captures the beautiful reds in sunsets or sunrises exactly as you see them.

Flash mode: Flash Cancel

Focus mode: Autofocus, autofocus + self-timer and infinity can be selected.



Night Landscape: Use for pictures that employ slow shutter speeds to produce stunning night landscapes.

Flash mode: Flash Cancel

Focus mode: Infinity and infinity + self-timer can be selected

* Slow shutter speed is selected. To avoid camera shake, place the camera on a flat surface or use a tripod.

• Note that when the shutter speed is slower than 1/4 sec., Noise Reduction (p. 154) is automatically activated and the time taken to save a picture to the CF memory card is approximately doubled.



Museum: Use for taking pictures in indoor locations such as museums where use of a flash is prohibited. Enables a clear picture to be taken without using the flash.

Flash mode: Flash Cancel

Focus mode: Autofocus and autofocus + self-timer, macro close-up, macro close-up + self-timer can be selected.

* In some situations, a slow shutter speed is selected. To avoid camera shake, be sure to hold the camera steady or use a tripod.



Note that in some museums or exhibitions, it is prohibited to take pictures, even without flash. Be sure to obtain permission before taking any pictures.



Fireworks Show: Use when photographing fireworks displays. The camera responds more rapidly to the shutter release button, to ensure that the firework is photographed at the correct moment.

Flash mode: Flash Cancel

Focus mode: Infinity

* Slow shutter speed is selected. To avoid camera shake, use a tripod.

• Note that when the shutter speed is slower than 1/4 sec., Noise Reduction (p. 154) is automatically activated and the time taken to save a picture to the CF memory card is approximately doubled.



Close Up: Use to take up-close pictures of subjects such as flowers or insects, with an artistically blurred background.

Flash mode: Flash Cancel

Focus mode: Macro close-up and macro close-up + self-timer can be selected.

Focus area: The AF-area mode is set to **Manual**, so you can select the focus area with the Multi selector (p. 101).

* In some situations, a slow shutter speed is selected. To avoid camera shake, be sure to hold the camera steady or use a tripod.



Copy: Use to obtain clear pictures of text or drawings on a white board, business card, or in printed matter. To shoot a close subject, set the camera to Macro close-up mode (p. 93).

Flash mode: Any mode can be selected.

Focus mode: Any mode can be selected.

* Colored text or drawings may be reproduced faintly difficult to see.



Back Light: Use when light is coming from behind your subject, throwing their features into shadow, or when your subject is in the shade but the background is brightly lit. The flash will fire automatically to illuminate ("fill in") shadows.

Flash mode: Anytime Flash

Focus mode: Autofocus and autofocus + self-timer can be selected.



Reviewing and Deleting

With a film camera, only when the film was developed would you know whether your pictures had turned out as you had hoped. Using the quick review function on your Nikon digital camera, on the other hand, you can view the results of earlier attempts while setting up the next shot, and use what you see to change camera settings or to choose a better angle. Was your last picture too dark? Take your finger off the flash window and try again. Does the brilliant white sand of the beach look dingy and grey? Raise exposure compensation (p. 100) and try again. Are the flowers in that close-up shot blurred? Turn on Best-Shot Selection (p. 141) and try again. Once you have the shot you want, you can delete your failures instantly to make room for more shots on the memory card.

Playback Mode (p. 155)

The review function described in this section allows you to view photos and movies without leaving shooting mode. Your Nikon digital camera is also equipped with a full playback mode, which can be accessed by turning the mode dial to . In playback mode, not only can you view pictures full frame or as thumbnails, view movies, and delete individual images, but you also have access to a menu of playback options that allow you to delete multiple images, protect images from deletion, view slide shows, select images for transfer to a computer, and prepare digital "print orders" for printing pictures directly from the CF memory card.

To use quick review, the camera must be in shooting mode. Press the QUICK  button once to display existing pictures at the top left corner of the monitor, twice to display pictures full screen. Pressing the button a third time returns you to shooting mode.

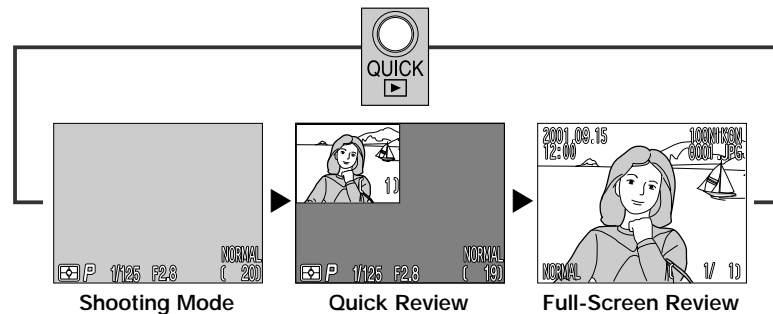

Shooting Mode

Quick Review

Full-Screen Review

Photos on the CF memory card are displayed in the top left corner of the monitor, allowing you to view the results of previous images while setting up your next shot.



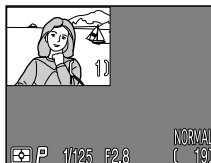

Photos on the CF memory card are displayed full screen or in menus of four or nine "thumbnail" images. You can play back movies, view photo information, delete images one at a time and create small pictures (p. 76).

Quick Review

When you press the QUICK  button to enter quick review mode, the most recent picture on the CF memory card will be displayed at the top left corner of the monitor.



The following operations can be performed:

To	Press	Description
View other pictures (including small pictures)		Press  to view images recorded before the current picture or  for pictures recorded after. Hold it down to scroll rapidly to the desired picture.
View current picture full screen	QUICK 	Enter full-screen review (see next page) with the current pictures displayed full screen.
End review and take more pictures	Shutter release button	Press the shutter release button halfway to end review and focus. Press all the way down to end review and take a picture.







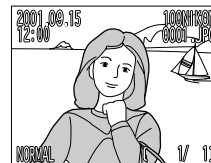









* All other camera controls function as they do in shooting mode.

Full-Screen Review

From quick review, press the QUICK  button to enter full-screen review. The picture displayed in quick-review mode will be displayed full screen.

















The following operations can be performed:

To	Press	Description
View other pictures (including small pictures)		Press  to view images recorded before the current picture, and  for images recorded after. Hold it down to scroll rapidly to desired picture. If there are small picture files, the small pictures will be displayed with a grey frame.
Hide picture information/turn monitor off		Hide and display camera settings; turn the monitor on and off.
Create small picture		Press  to create a small picture of the current picture.
Delete current picture		A confirmation dialog will be displayed. Press  /  on the Multi Selector to highlight the option and  to select. <ul style="list-style-type: none"> • Select "Yes" to delete picture • Select "No" to keep picture
View photo information		Press the  button to display next page of photo information (p. 158)
View multiple images		Press the  button to display a set of up to nine thumbnail images (see next page).
Select current picture for transfer to computer	TRANSFER button	Images marked for transfer to a computer are indicated by a  icon. To select the current image for transfer, press the TRANSFER button. If the current image is already selected for transfer, pressing TRANSFER will deselect it.
End review and take more pictures	Shutter release/QUICK  button	Press the QUICK  button to end review readying the camera for the next shot. To end review and focus, press the shutter release button halfway. To end review and take a picture, press the shutter release button all the way down.

Thumbnail Review

Pressing the  button in full-screen review displays a menu of nine thumbnail images. The following operations can be performed while thumbnails are displayed:



To	Press	Description
Highlight images		Press  /  /  /  on the Multi selector to highlight a thumbnail
View highlighted image at a larger size		With nine thumbnails displayed, press the  button once to view a menu of four thumbnail images. Press again to view highlighted thumbnail full screen. Small pictures are displayed with a grey frame.
Delete highlighted picture		A confirmation dialog will be displayed. Press  /  on the Multi selector to highlight the option and  to select. <ul style="list-style-type: none"> • Select "Yes" to delete picture • Select "No" to keep picture
Select highlighted picture for transfer to computer	TRANSFER button	Images marked for transfer to a computer are indicated by a  icon. To select the current image for transfer, press the TRANSFER button. If the current image is already selected for transfer, pressing TRANSFER will deselect it.
End review and take more pictures	Shutter release/ QUICK  button	Press the QUICK  button to end review readying the camera for the next shot. To end review and focus, press the shutter release button halfway. To end review and take a picture, press the shutter release button all the way down.

Selecting images for transfer to the computer

In full-screen review mode and thumbnail review mode, images to be transferred to the computer can be selected and deselected using the TRANSFER button.

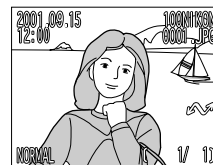





Full-Screen Review Mode

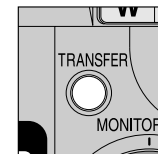

Thumbnail Review Mode



TRANSFER button

- Images marked for transfer to the computer are shown by the  icon. If you select an unmarked image and press the TRANSFER button, the  icon will appear and the image will be marked for transfer.
- If you select an image that is already marked for transfer and press the TRANSFER button, the  icon will disappear and the image will no longer be marked for transfer.
- Images can also be marked for transfer when the mode dial is turned to  and the camera is in playback (either single-image playback or thumbnail playback) mode (p. 156, 162).

Where Do I Go from Here?

When they have finished shooting, users of conventional film cameras typically take the film to be developed. But what do you do with pictures you have taken with a digital camera? This chapter offers some tips on how you can accomplish the following common tasks:

.....
How Do I Send Pictures to My Friends and Family?

Read this section for advice on distributing your pictures via e-mail and the Web.

How Do I Make Prints?

Learn about Digital Print-Order Format (DPOF) and how to take photos for printing.

How Do I Keep Track of My Photos?

This section provides an overview of how image database software can be used to view and organize your photos.

How Do I Send Pictures to My Friends and Family?

Distributing Photos by E-Mail and the Web

As the name indicates, digital cameras produce digital images. As digital data, digital images can be readily transferred to a computer, where they can be stored, viewed, sent to your acquaintances via e-mail, or saved to removable media (for example, a floppy or Zip disk) for delivery to a photofinisher.

The key to transferring images to a computer is the Nikon View software provided with your camera. This section describes how to take pictures for electronic distribution and transfer them to your computer. More information on using Nikon View can be found in "Reference: Connections" (p. 178).

Creating Small Picture Files for E-Mail and the Web

Your camera stores pictures in TIFF and JPEG format, which can be viewed using a wide variety of imaging software. JPEG images can even be displayed in web browsers, such as Netscape Navigator or Internet Explorer, and e-mail software such as Eudora and Outlook. This makes them ideal for distribution by e-mail or the web. Note, however, that pictures destined for electronic distribution should be small, both in terms of their physical dimensions (so that they will fit in the window of a web-browser or e-mail software) and in terms of the amount of data they contain (so that they don't take too long to upload or download over an Internet connection).

Image quality and size

Choosing an image quality of BASIC or NORMAL reduces file size so that images take less time to transmit over an Internet connection. Also, not only are VGA (640 x 480 pixel) images small enough to fit in a browser window when displayed on most computer monitors, the reduced size means that the file will transmit faster.

It is possible to adjust image quality and size settings in the SET-UP or CSM mode when taking pictures for electronic distribution. However, the COOLPIX885 can also create **small picture** files for e-mail and Web use at the press of a button.

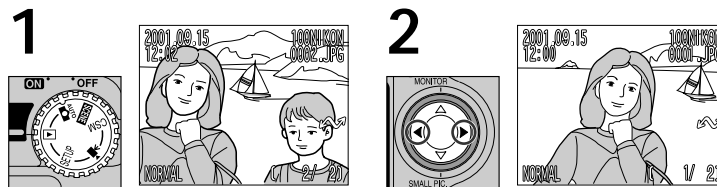

1 Display a picture in single-image playback or full-screen review to create a small picture file

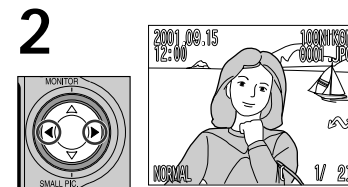

2 Press ◀▶ to select a picture



3 Press ▼ (SMALL PIC. button)

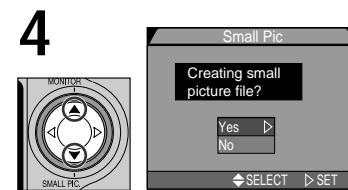

4 Press ▲/▼ to highlight "Yes"

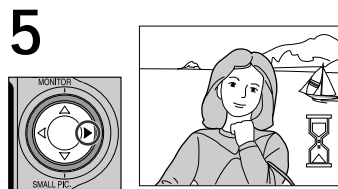

5 Press ▶ to create a copy of the photograph at the designated Small Picture size.

- A Small Picture file of the selected size (default: 640 x 480 pixels) is created.

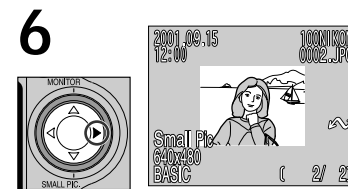

6 Press ▶ to confirm small picture

About Small Picture

- The image quality of the Small Picture is set to BASIC even if the image quality of the original photo file is set differently.

About Small Picture

- Small pictures created by the COOLPIX885 have names of the form of "SSCNnnnn.jpg", where nnnn is a four-digit number assigned automatically by the camera (e.g., "SSCN0002.jpg").
- The default Small Picture size can be set with the "Playback menu: Small Pic." menu option.
- In full-screen review or playback mode, Small Picture files are displayed at approx. 1/4 of full-frame size, centered with a grey frame. In thumbnail review or thumbnail playback, small picture is displayed with a grey frame.
- Small Pictures cannot be played back full-screen.
- Small Pictures are not displayed in Slide Show (p. 168).
- The Transfer marking setting of the small picture will be set to match those of the original photo file.
- The Protect, Print Set and hide image settings of the original photo file are not set automatically for the Small Picture file.

Changing the Small Picture size

Select option available in "Small Pic." menu in the playback menu (p. 175).
The Small Picture size can be changed to one of four sizes: 640 x 480, 320 x 240, 160 x 120 and 96 x 72 pixels.

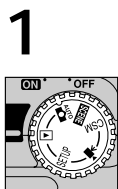

Set mode dial to

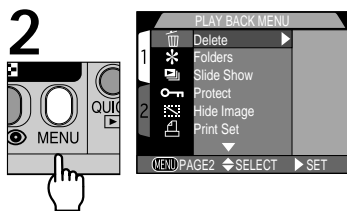

Press MENU button to display playback menu

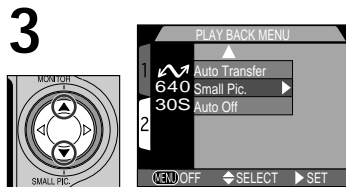

Highlight "Small Pic."

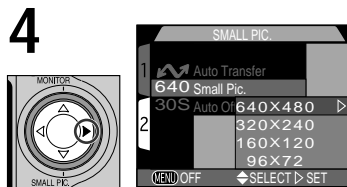

Display options

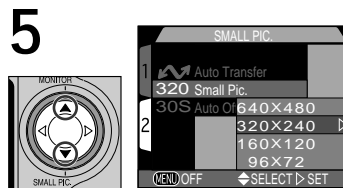

Choose a small picture size

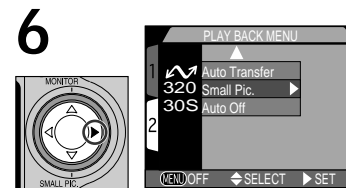

Press to set

Notes on creating a Small Picture

Small Pictures cannot be created in the following conditions:

- When an image file, "DSCN9999.jpg", is present in a folder
- When 200 image files are present in a folder
- When a Small Picture is being displayed in the monitor
- With an image file of HI image quality
- With Ultra HS or movie files
- When there is insufficient memory in the CF memory card to create a Small Picture
- In quick review, thumbnail review and thumbnail playback

Notes on deleting Small Pictures

- When a Small Picture is deleted, the original photo is left untouched.
- The Small Picture is left untouched even if its original photo file is deleted.

Notes on Small Picture

- When using Nikon View Ver. 4, small picture files can be displayed in thumbnail; however, they may not be displayed or printed properly with the built-in viewer.
- When small pictures created with the COOLPIX885 are used with a digital camera other than the COOLPIX885, small pictures may not be displayed or transferred to the computer properly.
- COOLPIX885's small picture function is not guaranteed for pictures taken with other digital cameras.



Distributing Images Electronically

Once you have created the images you want to send, you can transfer them to your computer for distribution via e-mail.

1 Install Nikon View

- Install Nikon View and the image database software provided your camera as instructed in "Reference: Connections" (p. 178).

2 Select the images to be transferred

- After turning the mode dial to , turn the camera on and press the  button to display a page of thumbnail images (p. 162). Check that the images you want to transfer are marked with a  icon. To select unmarked pictures for transfer or to deselect pictures already marked for transfer, highlight the picture and press the TRANSFER button.
- If the original picture file is marked for transfer, small picture file create from that file is also marked for transfer. However, unmarking transfer setting of either the original or small picture files does not affect the transfer status of the other.

3 Connect the camera to the computer

- Turn the computer on and connect your camera as described in "Reference: Connections" (p. 178). When the camera is connected and turned on, Nikon View will start automatically.

Caution regarding image transfer

Do not carry out any of the following operations while images are being transferred to the computer after TRANSFER button has been pressed.

- Remove the CF memory card
- Turn the camera off
- Disconnect the USB cable

- See p. 121 for more information on selecting images for transfer as they are taken.
- See p. 174 for more information on selecting images for transfer after they are taken.

4 Transfer marked images

- Press the TRANSFER button on the camera to copy all images marked for transfer to the computer. The message "PREPARING TO TRANSFER" will appear in the camera monitor. After a brief pause, transfer will begin, and the message "TRANSFERRING IMAGE TO COMPUTER" will be displayed.

5 Disconnect the camera

- When all selected images have been transferred, the monitor will show "TRANSFER COMPLETED". Once the "TRANSFER COMPLETED" message has appeared, click the "Unplug or Eject Hardware" icon and select Stop USB disk (Windows Millennium Edition, Windows 2000), or double click My Computer, select the removable disk corresponding to the camera, open the File menu and select Eject (Windows 98, Windows 98 SE) or drag the untitled volume corresponding to the camera into the Trash (Macintosh). Then turn the camera off and unplug the USB cable (p. 178). The images (especially Small Pictures) that have been copied to your computer can be appended to e-mail messages (see the documentation provided with your e-mail application for details) or uploaded to your personal home page.

PREPARING
TO TRANSFER



TRANSFERRING
IMAGE TO
COMPUTER



TRANSFER COMPLETED

Note on Connecting to Your Computer

When the camera is connected to the computer and camera is turned on, the lens extends out. Make sure to remove the lens cap of the camera before connecting the camera to the computer.

Image Database Software

Depending on where you purchased your camera, the COOLPIX885 comes with Canto Cumulus, iView Media Pro, or Fotostation Easy. The documentation on the Nikon View 4 reference CD included with your camera provides instructions for installing these applications (p. 179). If you will be using Cumulus or iView Media Pro, remember to install the image database software before installing Nikon View. If you will be using Fotostation Easy, install Nikon View 4 first, and then install Fotostation Easy.

How Do I Make Prints?

From Data to Paper

Digital photographs can be printed in a variety of ways. Many photofinishers now take delivery of image files on CompactFlash™ memory cards or on disk. Some photofinishing systems and personal photo printers also comply with Digital Print Order Format (DPOF), allowing you to print pictures from digital “print orders” that are stored on the camera memory card. If you have a suitable printer, you can also print pictures at home using Nikon View. Many newer color printers for the home market offer near photo-quality prints at an affordable price. This section describes how to take pictures for printing and outlines some of the options available for getting prints.

Taking Pictures for Printing

Image size and, to a lesser extent, quality, are important considerations when taking pictures for printing. Image size determines the maximum size at which the picture can be printed. If a small-size image is printed at a large size, the individual dots that make up the photo (pixels) will be visible to the naked eye, giving the picture a rough, uneven appearance. Many household ink-jet printers have a target resolution for printing color images of around 200 dots per inch. At this resolution, a VGA image 640 x 480 pixels in size will print at a size of Approx. 8 x 6 cm (3.1 x 2.4 in.), while a full-size image will print at about Approx. 20 x 15 cm (7.9 x 5.9 in.).

The higher the image quality and size, the better the results when the picture is printed, particularly at larger print sizes. We recommend that you set image quality to FINE or NORMAL and image size to XGA or FULL when taking images that you intend to print at a later date. See the instructions in the preceding section for information on setting image size and quality (p. 103).

Digital Print-Order Format (DPOF)

The Print Set option in the playback menu is used to create a digital “print order” that is stored on the memory card in Digital Print-Order Format (DPOF). Once you have prepared a print order, the card can be removed from the camera and inserted in a DPOF-compatible device, be it a personal photo printer or a photofinisher’s print system, and pictures printed directly from the card. To create a digital print order:

1

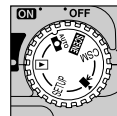

After inserting the CF memory card containing the pictures you want to print into the camera, turn the camera on and set the mode dial to 

2

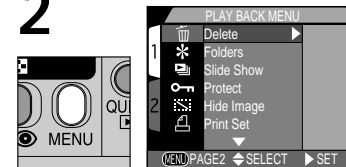

Press MENU button to display playback menu

3

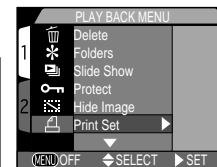
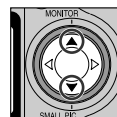

Highlight Print Set

4

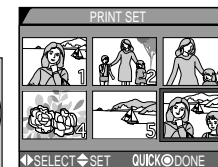
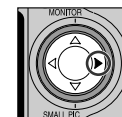

Display PRINT SET menu

5

Select images for printing as described in “Ordering Prints: The Print-Set Menu” (p. 172).

- Print order will be stored on CF memory card and can be added to or altered at any time. Before printing pictures, turn camera off and remove card.

Printing from Removable Media

Even if your photofinisher does not offer support for DPOF, you may still be able to get professional prints made by copying the pictures you want to print to a floppy disk or other removable media and taking the disk to your photofinisher (check with your photofinisher first for information on pricing and the types of disks and file formats supported). Pictures can be copied to disk using Nikon View. For information on the operations that can be performed while the camera is connected to your computer, see the Nikon View Reference Manual.

Once you have transferred large numbers of photos to your computer, you may have trouble finding that picture you took of your aunt “a month or two ago” should you suddenly decide you want extra prints. The image database software included with your camera can make it easier for you to find the photo you want by organizing pictures into categories. Image database software can also be used to preview the pictures stored in your computer and to open them in your favorite imaging application. For details, see the documentation provided with the image database software.

Image Database Software

Depending on where you purchased your camera, the COOLPIX885 comes with Canto Cumulus, iView Media Pro, or Fotostation Easy. The documentation on the Nikon View 4 reference CD included with your camera provides instructions for installing these applications (p. 179). If you will be using Cumulus or iView Media Pro, remember to install the image database software before installing Nikon View. If you will be using Fotostation Easy, install Nikon View 4 first, and then install Fotostation Easy.

Reference

This chapter is divided into the following sections:

.....
Beyond Point-and-Shoot

Read this section for information on camera controls such as zoom, flash, focus, and operating mode.

Camera Setup

Learn how to configure the camera using the options available in the SET-UP menu.

Advanced Photography

This section details the options available in the CSM shooting mode.

Playing Images Back

Read this section for a detailed description of playback mode.

Connections

How to connect your camera to a computer and transfer images using Nikon View.

Technical Notes

This section describes how to care for camera and what to do when it does not function as expected. It also lists camera specifications and optional accessories available for the COOLPIX885.

Index

An alphabetical index to the topics covered in this manual.

The Details

Beyond Point-and-Shoot
pp. 88-101

Camera Setup
pp. 102-125

Advanced Photography
pp. 126-154

Playing Images Back
pp. 155-175

Connections
pp. 178-186

Technical Notes
pp. 187-205

Index
pp. 202-205

This section covers operations that can be performed in auto (AUTO), scene, CSM and movie modes using the mode dial and the buttons on the back of the camera.

Creative Photography: Choosing a Mode

Although Auto Mode is suited to almost any situation, some common compositions, such as portraits or landscapes, require special combinations of settings that apply to any scene of the same type. Rather than adjusting settings one-by-one to suit the composition, you can simply choose the appropriate scene from the Scene Mode menu, and let the camera adjust settings automatically to produce the best possible results.

In addition to the Auto and Scene mode, some camera controls are only available in CSM Mode.



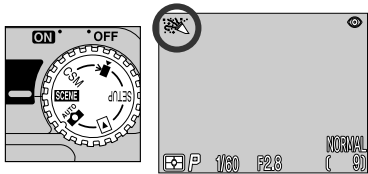



This section describes when to use each of the Modes. To choose a Mode, turn the mode dial to the appropriate position (and select the appropriate composition type from the Scene Mode menu). When one of the Scene Modes is chosen, an icon corresponding to the current mode will be shown in the top left corner of the monitor. The movie mode icon appears in the bottom left corner of the monitor. No icon is displayed in Auto and CSM Modes.



Scene Settings

Depending on the subject, scene modes may not always produce the desired results. If you are dissatisfied with pictures taken in one of the scene modes, set the mode dial to AUTO and try again.

The table below illustrates when to use each of the shooting modes. The icons in the “Flash Mode” (p. 98) and “Focus Mode” (p. 93) columns show the flash and focus-mode settings that can be selected in each operating mode. Where more than one option is listed, the user can choose which setting to use.

Mode	When to Use It	Flash Mode	Focus Mode
 AUTO	An automatic mode for simple, “point-and-shoot” photography. Use for snapshots. Auto mode is also recommended for pictures that will later be retouched on a computer.	Any	Any
 SCENE	In this mode, most camera settings are automatically adjusted to suit the chosen scene. Twelve choices of scene are available. See p. 65 for the details and restrictions on each scene.	*	*
 CSM Custom	In CSM shooting mode, various setting can be adjusted one-by-one to suit the composition.	Any	Any
 Movie	Record silent movies 320 x 240 pixels in size (QVGA). Recording begins when shutter release button is pressed all the way down and ends when shutter release button is fully pressed a second time. In place of number of exposures remaining, exposure counts display in monitor shows length of movie that can be recorded. Movies end automatically after 40 sec. or when no more space is available on CF memory card. Movies are stored as Quick Time movie files with names ending in “.MOV”.		Auto 

* Depending on the scene selected, you may be able to adjust flash and focus mode settings (see p. 65-67 for restrictions).

Framing Pictures: Optical and Digital Zoom

Your Nikon digital camera offers two kinds of zoom: optical zoom, in which the camera's telescoping lens can be used to magnify the subject up to 3X, and digital zoom, in which digital processing is used to further magnify the image up to 4X

Optical Zoom

Pictures can be framed in the viewfinder or monitor using the zoom button.

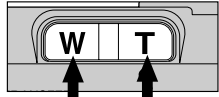

Zoom out Zoom in

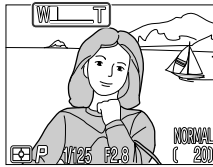

Indicator in monitor displays amount of zoom while either **W** or **T** is pressed.

Digital Zoom

At the maximum zoom position, holding the **T** down for two seconds triggers digital zoom.

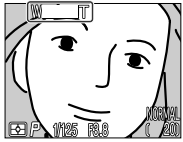

Maximum optical zoom position

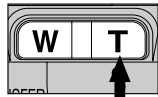

Hold for 2 sec.

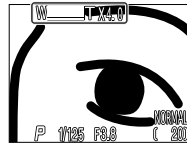

Zoom factor displayed in monitor

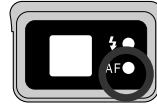

Green light blinks slowly to show that pictures can not be accurately framed in viewfinder

While digital zoom is in effect, the zoom factor increases each time the **T** is pressed, to a maximum of 4X. Pressing the **W** decreases the zoom factor. To cancel digital zoom, press the **W** button until the zoom indicator disappears.

Optical vs. Digital Zoom

In digital zoom, data from the camera's image sensor are processed digitally, enlarging the center portion of the image to fill the frame. Unlike optical zoom, digital zoom does not increase the amount of detail visible in the picture. Instead, details visible at maximum zoom are enlarged, producing a slightly "grainy" image. Digital zoom also differs from optical zoom in that its effects are visible only in the monitor, not the viewfinder, meaning that the monitor must be on before digital zoom can be used.

Restrictions on Digital Zoom

As noted above, digital zoom can only be used when the monitor is on. Digital zoom is not available in movie mode.

Focusing Near and Far: Focus Mode Button

By default, the camera adjusts focus automatically for subjects 30 cm/ 1 ft. (at widest angle), 60 cm/2 ft. (at telephoto) or more from the lens, which is ideal for snapshots. Under some circumstances, however, you may want to force the camera to focus on distant objects rather than on the closest object visible in the center of the frame—for example, when photographing a distant landscape through a screen of branches or when taking a shot through a window. Or you may want the camera to focus on something closer than 30 cm—for example, to create a close-up of a flower or business card. Your Nikon digital camera offers focus modes for both situations. Some focus modes can be combined with a timer to delay shutter release, either to keep the camera from shaking or to allow you to appear in your own photographs.

To select the focus mode, press the  button, which may be found below the monitor on the back of the camera.



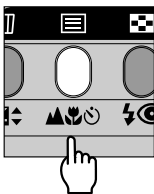

1 Press



2 Confirm focus mode setting in monitor



The following settings are available (restrictions may apply depending on the mode selected).

Setting	How It Works	When to Use It
No icon Autofocus	Camera automatically adjusts focus according to distance to subject.	Use with subjects 30 cm (1 ft.) <at widest angle>, 60 cm (2 ft.) <at telephoto> or more from lens.
 Autofocus + self-timer	Combines autofocus with self-timer duration of 10 or 3 sec.	Use for self-portrait or prevent pictures from blurring when shutter release button is pressed.
 Infinity	Focus is fixed at infinity. Flash is disabled.	Use when photographing distant scenes through foreground objects such as a window.
 Macro close-up	Camera can focus on objects as close as 4 cm (1.6 in.) <at widest angle> or 30 cm (1 ft) <at telephoto>, (measure from lens)	Use for close-ups.
 Macro close-up + self-timer	Combines macro close-up with shutter-release delay of 10 or 3 sec.	Use for close-ups to prevent pictures from blurring when shutter release button is pressed.

Macro Close-Up

To take pictures of subjects within 30 cm (11.8 in.) or closer in macro close-up mode, set the zoom position to widest angle; you can focus as close as 4 cm (1.6 in.) from the lens. At zoom position where  is displayed in yellow, you can focus as close as 10 cm (3.9 in.) from the lens.

- We recommend that you frame pictures in the monitor when using macro close-up.
- While the flash can be used in macro close-up mode, it may sometimes be unable to light the entire subject. Take a test picture and verify the results in the monitor.

Autofocus mode

The autofocus system operates in one of two modes, depending on whether the monitor is on or off.

AF mode	How It Works	Pros and cons
Continuous AF (monitor on)	Camera adjusts focus continuously. Focus can be locked by pressing the shutter release button halfway.	Pro: <ul style="list-style-type: none"> Minimizes time needed for camera to focus, allowing you to react quickly when presented with a sudden opportunity to capture the perfect shot. Con: <ul style="list-style-type: none"> Pictures can be taken when camera is not in focus; check green light before shooting.
Single AF (monitor off)	Camera focuses only when shutter release button is pressed halfway	Pros: <ul style="list-style-type: none"> Pictures can be taken only when camera is in focus. Saves battery Con: <ul style="list-style-type: none"> Slight delay before camera focuses.

Getting Good Results with Autofocus

Autofocus performs best when:

- There is contrast between the subject and the background. For example, autofocus may not perform well on subjects that are the same color as the background.
- The subject is evenly lit.

Autofocus does not perform well when:

- You attempt to focus simultaneously on two or more objects at different distances from the camera. For example, autofocus may not perform well when photographing an object inside a cage, because the bars of the cage will be closer to the camera than the main subject, and both the bars and the main subject will be in focus area at the center of the frame.
- The subject is very dark (the subject should not, however, be too much brighter than the background).
- The subject is moving rapidly.

If the camera is unable to focus using autofocus, use focus lock (p. 61) to focus on another subject at the same distance.

Delaying Shutter Release: Self-Timer Mode

When the self-timer is used, the camera will not take a picture until ten or three seconds after the shutter-release button is pressed. The ten-second timer is generally used for pictures in which you wish to appear yourself, when it gives you time to position yourself in front of the camera after pressing the shutter-release button. The three-second timer prevents pictures from being blurred by camera movement that occurs when the shutter-release button is pressed. This feature is most useful when taking low light or close-up shots with the flash turned off.

To use the self-timer:

1 Position the camera

- Mount the camera on a tripod (recommended) or rest it on a flat, stable surface.

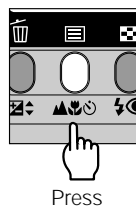

2 Select a self-timer mode



Press



Self-timer icon displayed in monitor

- Press the  button until either  (autofocus + self-timer, for pictures at ranges of 30 cm/1 ft. or more at widest angle or 60 cm/2 ft. or more at telephoto) or  (macro close-up + self-timer, for pictures at ranges of 4 cm/1.6 in. or more at widest angle or 30 cm/1 ft. or more at telephoto) appears in the monitor.

3 Compose the picture

- Adjust camera settings and frame the picture.

4 Start the timer

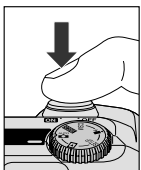

Full press



Countdown timer in monitor shows number of seconds remaining until picture is taken

- Press the shutter-release button all the way down to activate the timer. Press once for a ten-second delay, twice for a three-second delay.
- The self-timer lamp next to the flash window will start to blink when the shutter release button is pressed, and continue to blink until one second before the photo is taken. The self-timer lamp will stay lit during the final second to warn that the shutter is about to be released.
- To stop the timer, press the shutter-release button twice with the 10-second delay and once with the 3-second delay.

Note on using self-timer

When using the self-timer with off-center subject, select “Manual” option in “FOCUS OPTIONS > AF-Area Mode” in CSM shooting mode and select appropriate focus area, then set the self-timer. Or, select “Close Up” in scene mode and select appropriate focus area, then set the self-timer.

Throwing Light on Your Subject: The Flash Button

The flash can be adjusted for a variety of situations, as described in the table opposite under the heading, “When to Use It.”

To select a flash setting, press the  button.

1

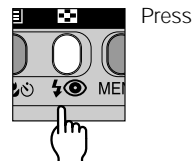

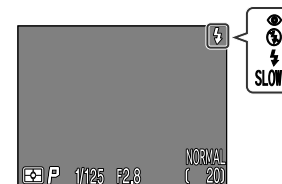

2











Confirm flash setting in monitor

When Lighting Is Poor



When lighting is poor and the flash is off () or set to slow sync (SLOW), pictures may be blurred. Use of a tripod is recommended in these circumstances. At shutter speeds of below 1/4 sec., the shutter speed indicator in the monitor will turn yellow. Pictures taken when this indicator appears may be blurred or slightly mottled. To prevent this, try zooming the camera out. At shutter speeds of below 1/4 sec., noise may also appear in the dark part of the frame. This noise in the form randomly spaced bright-colored pixels can be reduced with the Noise Reduction setting.

Note that the flash will turn off () automatically when:

- Autofocus is set to “Infinity” (; p. 93)
-  (landscape),  (sunset),  (night landscape),  (museum),  (fireworks show) or  (close up) is selected in scene mode (p. 63) or the mode dial is set to  (movie) (p. 89)
- BSS is on (p. 141) or a setting other than Single is selected for CONTINUOUS (p. 139) in CSM mode
- You use lens converter (LENS) settings (p. 145)
- The AE Lock option in the Exposure Options sub-menu is on (p. 148)

See p. 6 for more information on “safe flash use”.

The following settings are available (restrictions may apply depending on the mode selected):

Setting	How It Works	When to Use It
No icon Auto	Flash fires when lighting is poor.	Best choice in most circumstances.
 Flash Cancel	Flash will not fire even when lighting is poor.	Use when subject is outside range of flash, to capture natural lighting under dim light, or where use of a flash is prohibited. Use of a tripod is recommended to prevent blurring.
 Auto with red-eye reduction	Pre-flash lamp lights before main flash. This causes subject's pupils to contract before main flash fires, minimizing "red-eye" effect caused by flash reflecting from retina.	Use for portraits (works best when subjects are well within range of flash and looking at pre-flash lamp). Between your pressing shutter-release button and the picture being taken, there is a slight delay to allow the pre-flash lamp to take effect, and consequently red-eye reduction is not recommended with subjects that are moving erratically or in other situations in which you want the camera to react quickly.
 Anytime Flash (fill-flash)	Flash fires whenever picture is taken.	Used to "fill-in" (illuminate) shadows and backlit subjects.
SLOW Slow Sync	Auto flash combined with slow shutter speed.	Use to capture both subject and background at night or under dim light. Use of a tripod is recommended to prevent blurring.

The Flash-Ready Light

A short pause is required between exposures for the flash system to charge. If the shutter release button is pressed halfway while the flash is charging, the red light next to the viewfinder will blink. Remove your finger briefly from the shutter release button and try again.

Keep the Flash Window Clear

Keep your fingers and other objects away from the flash window when using the flash. If a shot seems dark even though the flash fired, this may indicate that you accidentally blocked the flash window; check that the flash is unobstructed and try again.

Bright, Dark, and High-Contrast Subjects: Exposure Compensation

To obtain the desired result with certain subject compositions (for example, when large areas of the frame are very bright, very dark, or contain areas of strong contrast), it may be necessary to alter exposure from the value suggested by the camera. This can be done using exposure compensation.

Exposure compensation can be set to values between +2.0 EV (overexposure) and -2.0 EV (underexposure) in increments of 1/3 EV. Press ▲/▼ on the Multi selector while holding the  button.

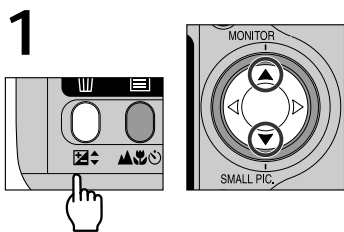

Press ▲ to increase exposure value, ▼ to decrease exposure value.

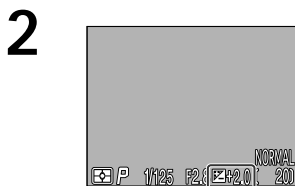

Confirm exposure value in monitor. Effects of compensation are visible in monitor; adjust until desired result is achieved.

 icon is displayed in monitor.

Exposure compensation is not available in manual exposure mode, when the user adjusts exposure directly by adjusting shutter speed and aperture (p. 127).

- By default, the camera “remembers” the exposure-compensation value restoring it the next time the mode dial is set to CSM. If desired, exposure compensation can be set to return to ± 0.0 EV when the mode dial is turned to a new setting or the camera is turned off (p. 118).
- Exposure compensation can also be set using the “EXPOSURE OPTIONS > Exp. +/-” item in the shooting menu (p. 149).

Choosing a Focus Area: Manual Focus-Area Selection

In AUTO mode, the camera automatically focuses on the subject in the center focus area. At SCENE-mode settings of “Portrait” and “Close Up” (p. 65, 67), or when “Manual” is selected in the “FOCUS OPTIONS > AF Area Mode” sub-menu for CSM mode (p. 150), the focus target can be chosen from one of five focus areas. This makes it possible to focus on an off-center subject without using focus lock.

The focus area can be selected using the Multi selector.

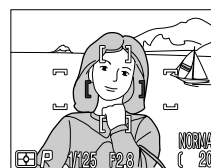

Center focus area selected.

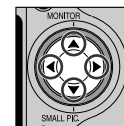

Use Multi selector to select new focus area.

- Any of five focus areas can be selected.

Focus-area selection can be used in combination with focus lock if the subject would not fall in any of the focus area in the final composition. In CSM mode, it can also be used in combination with spot AF-area metering (p. 137) to lock the spot metering point to the selected focus area.

Manual focus-area selection is not available when the monitor is off or digital zoom is in effect (p. 90). In these cases, the center focus area is used.

When “Auto” (the default) is selected in the “FOCUS OPTIONS > AF Area Mode” sub-menu for CSM mode (p. 150), the camera automatically selects the focus area containing the subject closest to the camera. No focus area indicators appear in the monitor until the shutter release button is pressed halfway, when the active focus area is shown in red. Focus-area selection can be deactivated in CSM mode by selecting “Off” in the “FOCUS OPTIONS > AF Area Mode” sub-menu. In this case, the center focus area is used.

This section details the options available in the SET-UP menu, where you make changes to basic camera settings, and perform such tasks as formatting CF memory cards. The SET-UP menu can also be used to set image quality and size and choose a folder for storing images and for playback. Some of the options in the setup menu can also be accessed from the CSM and playback menu.

To view the SET-UP menu:

The SET-UP menu is displayed automatically when the mode dial is turned to SETUP.

To end display of the SET-UP menu, set the mode dial other than SETUP or turn the camera off.

The setup menu contains two pages of options:

SET-UP 1 menu

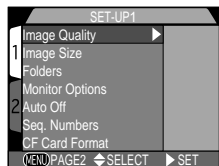
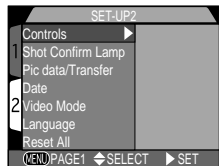

Image Quality	P. 103-107
Image Size	P. 103-107
Folders	P. 108-112
Monitor Options	P. 113-114
Auto Off	P. 115
Seq. Number	P. 116
CF Card Format	P. 117

SET-UP 2 menu



Controls	P. 118
Shot Confirm Lamp	P. 119
Pic data/Transfer	P. 120-121
Date	P. 122
Video Mode	P. 122
Language	P. 123
Reset All	P. 124-125

Making Effective Use of Memory: The Image Size & Quality Menu

Together, image quality and size determine how much space each picture occupies on the CF memory card. This in turn determines the total number of pictures that can be stored. To get an idea of how different settings for image size and quality affect the number of images that can be stored on a CF memory card, view the following table, which shows the approximate number of pictures that can be stored on 8 MB, 16 MB, 32 MB, and 64 MB cards at different combinations of image size and quality.

Note that the number of pictures that can be stored at each combination also varies according to their composition (detail, number or colors).

	8 MB Card			16 MB Card		
	FULL	XGA	VGA	FULL	XGA	VGA
HI	0	—	—	1	—	—
FINE	5	19	48	10	39	97
NORMAL	10	37	88	20	76	177
BASIC	19	71	161	39	144	324

	32 MB Card			64 MB Card		
	FULL	XGA	VGA	FULL	XGA	VGA
HI	3	—	—	6	—	—
FINE	20	79	195	40	159	390
NORMAL	40	152	354	81	309	725
BASIC	79	288	650	159	588	1300

Image Quality

To reduce the amount of memory that each picture occupies, images are compressed using JPEG compression. JPEG compression analyzes images in blocks eight pixels on a side and selectively reduces detail within each block. The more the image is compressed, the smaller the resulting file and the less space it occupies on the CF memory card. Compressing the image to make a very small file, however, may cause the block pattern to become visible, and there may be noticeable loss of detail. The actual effect depends on the size of the image when printed or displayed and on the type of subject.

You can control the amount of compression using the image quality sub-menu. Image quality settings can be accessed from the SET-UP menu and the “Image Size & Quality” sub-menu in the CSM shooting menu (p. 134). Changes to image quality in any of these menus apply to all modes. Note, however, that image quality setting of “HI” cannot be selected with the SETUP menu and “HI” becomes “FINE” in AUTO and SCENE modes, reverting to “HI” when the mode dial is turned to CSM.

The image quality menu contains the following options:

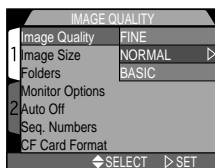

Option	File format	Description
HI	TIFF	Best-quality image, with no compression. Use when quality or authenticity is of paramount importance.
FINE	JPEG	Fine image quality, suitable for enlargements or high-quality prints. File size reduced to roughly 1/4 of original.
NORMAL	JPEG	Normal image quality, suited to most applications. File size reduced to roughly 1/8 of original.
BASIC	JPEG	Basic image quality, suitable for pictures that will be distributed by e-mail or used in web pages. File size reduced to roughly 1/16 of original.

While setting of “NORMAL” represents the best trade-off between file size and image quality in most cases, a setting of “BASIC” can be used to save memory or create smaller files suitable for electronic distribution. Setting of “HI” or “FINE” are suitable for pictures that will be enlarged or printed at high resolution.

JPEG

“JPEG” (pronounced “jay-peg”) stands for “Joint Photographic Experts Group,” the organization which developed the JPEG compression standard.

Viewing the Current Image Quality and Size

The current image quality and size (except for full size) settings are displayed in the monitor as shown at right.



Image Size

The image-size menu controls the physical dimensions of the image, measured in pixels. Smaller sizes require less space to store, making them suited to distribution by e-mail and the web. Conversely, the larger the image, the larger the size at which it can be printed without becoming noticeably “grainy.” Choose an image size according to the space available on the CF memory card and the task at hand.

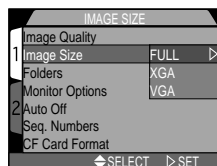

Image size can be adjusted from the SET-UP menu and the “Image Size & Quality” sub-menu in the CSM shooting menu (p. 134). Changes to image size in any of these menus apply to all modes.

The image-size menu contains the following options:

Option	Size (pixels)	Application
FULL	2048 x 1536	For high quality prints of up to A4 without additional treatment.
XGA	1024 x 768	Suited to printing at smaller sizes (for example, as an illustration in a letter or report), or to display on monitors 17 in. or larger.
VGA	640 x 480	Can be displayed full screen on 13 in. monitors. Suited to distribution by e-mail or the web.

Small Pictures

With COOLPIX885 digital camera, Small Pictures, 640 x 480, 320 x 240, 160 x 120 or 96 x 72 pixels in size, for e-mail and the web can easily be created with the SMALL PIC. button. See p. 76

Print Size

The size of images when printed depends on the resolution of the printer (the higher the resolution, the smaller the final print size). The following table shows how images of different sizes will print at a resolution of 200 dpi (supported by most household inkjet printers).

Print Size	Dimensions When Printed at 200 dpi
FULL	Approx. 26 x 20 cm (10.2 x 7.9 in.)
XGA	Approx. 13 x 10 cm (5.1 x 3.9 in.)
VGA	Approx. 8 x 6 cm (3.1 x 2.4 in.)

- See p. 175 for more information on choosing an image size for electronic distribution.
- See p. 107 for more information on choosing an image size for printing.

Organizing Your Pictures: The Folders Menu

By default, pictures are stored on the CF memory card in a folder labeled NIKON. To make it easier to locate pictures during playback, you can create additional folders and organize pictures by theme. The “Folders” sub-menu is used to create, rename and delete folders and to select the folder in which subsequent pictures will be stored or from which pictures are played back.



The camera file system conforms to the Design Rule for Camera File System (DCF). Under this system, folder names consist of a three-digit folder number followed by the folder name (e.g., “100NIKON”). Each folder can hold a maximum of 200 images (it may hold less, depending on the size of the CF memory card and other factors). Should a folder fill up, another folder will automatically be created with the same name but a different folder number (e.g., “101NIKON”). For most purposes, the folder number can be ignored—when viewed from the camera, folders with the same name but different folder numbers are the same folder. For example, the camera shows the folders “100NIKON” and “101NIKON” as the single folder “NIKON” with no folder number. When the CF memory card is viewed on a computer, however, folders with the same name but different folder numbers will be treated as separate folders (see the “Nikon View Reference Manual” for details). If you have trouble locating a photo on a computer, you can play it back on the camera, where the folder number and name are shown in the photo-information display.

Creating, Renaming and Deleting Folders: The Folder Options Menu

The folder options menu can be used to create, rename or delete folders.

— Creating New Folders —

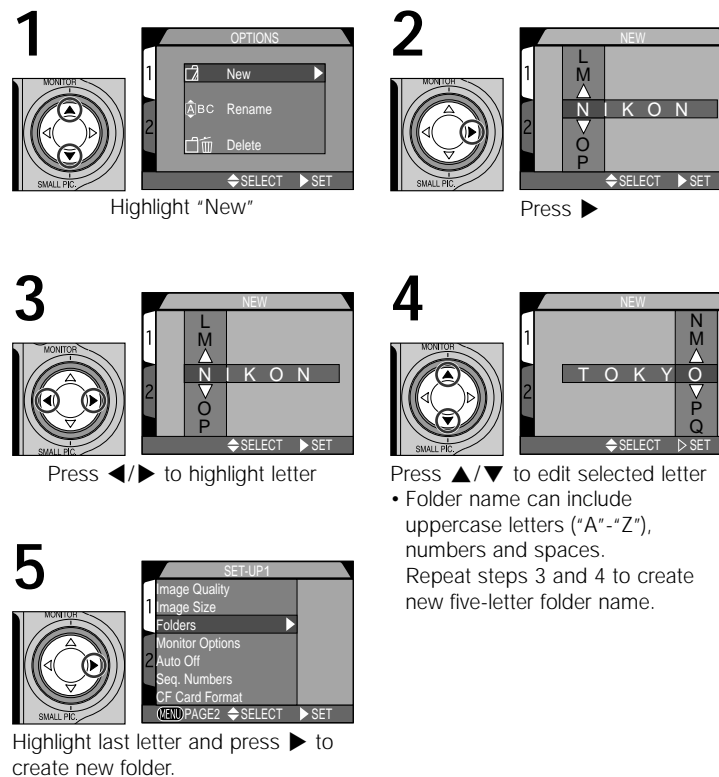

Until a different folder is selected from the “Folders” menu, all subsequent pictures will be stored in the new folder.

— Renaming Existing Folders —

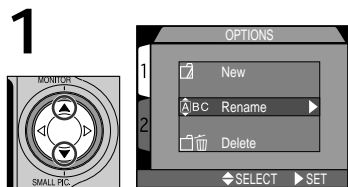

Highlight "Rename"

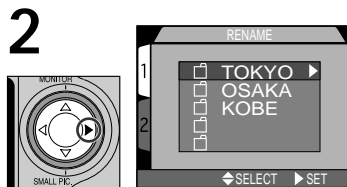

Press **▶** to display list of folders

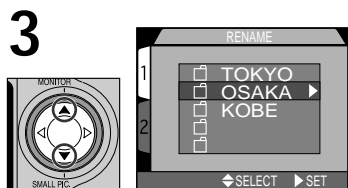

Highlight folder name

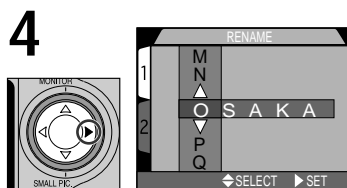

Press **▶**

- Edit name as described in steps 3-5 of "Creating New Folders" on preceding page.

— Deleting Folders —

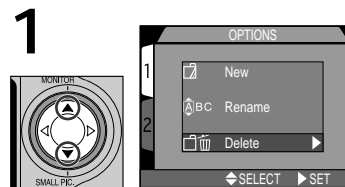

Highlight "Delete"

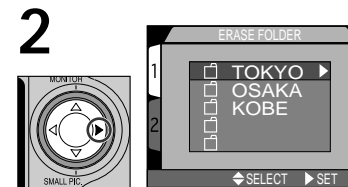

Press **▶** to display list of folders

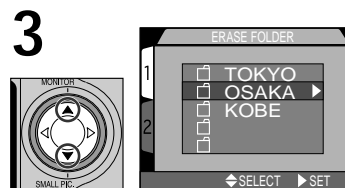

Highlight folder name

- Folder NIKON is not available for deletion.

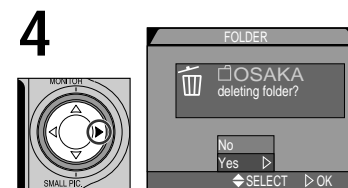

Press **▶**

- Select "Yes" to delete selected folder.
- Select "No" to return to SET-UP menu without deleting folder

If the selected folder contains hidden (p. 171) or protected (p. 170) images, the folder will not be deleted. Any images it contains that are neither hidden nor protected will, however, be deleted.

— Choosing a Folder —

Once additional folders have been created, you can select the folder that will be used for playback or to store pictures in all modes. The folder can be chosen using the “Folders” sub-menu in SETUP mode or “Folders” item in the playback menu. Until a new folder is selected, all subsequent images will be stored in this folder, which will also be used for playback.

1

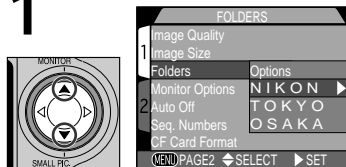

Highlight folder name.

2

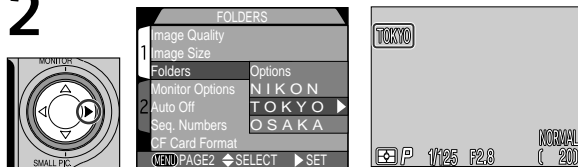

Press ►

- Folder name is shown in monitor. (No folder name is displayed when NIKON is selected.)

Each series of seventy pictures taken at a setting of “Ultra HS” is stored in a separate folder with a name consisting of “N_” followed by a three-digit number assigned by the camera. The “Folders” menu can be used to select the folder for playback or to delete the entire folder and all images it contains. Note, however, that such folders cannot be used to store pictures take after the folder was created.

Monitor Options

The “Monitor Options” sub-menu is used to specify when the monitor will turn on automatically and to set monitor brightness and hue (tone).

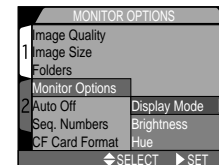

Controlling the Monitor: The Display Mode Menu

This option is used to specify the conditions under which the monitor will turn on automatically, and to specify whether or not pictures are displayed in the monitor after shooting.

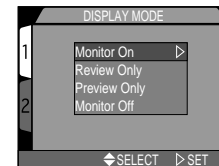

Option	Description
Monitor On	Monitor turns on at start-up; pictures are displayed in monitor after shooting.
Review Only	Monitor turns on only to display pictures immediately after shooting. Choose this option to save batteries.
Preview Only	Monitor turns on at start-up, but pictures are not displayed in monitor after shooting.
Monitor Off	Monitor remains off at all times. This option is the most effective for saving batteries.

Adjusting Monitor Brightness: The Brightness Menu

This option controls monitor brightness. Press ▲/▼ on the Multi selector to increase or decrease the brightness of the monitor by moving the arrow at the right side of the display up or down. Once you have adjusted brightness to your satisfaction, press ► on the Multi selector to put the change into effect.

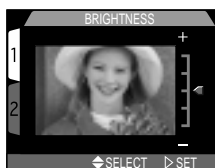

Increasing monitor brightness also increases the brightness of images output on a television set when the camera is connected to a television or VCR. Under normal conditions, this may make the image on the television slightly too bright.

Adjusting Monitor Tone: The Hue Menu

This option controls the hue (tone) of the monitor. Press ▲/▼ on the Multi selector to alter the hue by moving the arrow at the right side of the display up or down. Once you have adjusted hue to your satisfaction, press ► on the Multi selector to put the change into effect.



Conserving Battery Power: The Auto Off Menu

When operated on battery power, the camera will enter sleep mode if no operations are performed for thirty seconds (or three minutes when menus are displayed). The time limit for sleep mode can be chosen from thirty seconds, one minute, five minutes, and thirty minutes using the "Auto Off" menu.

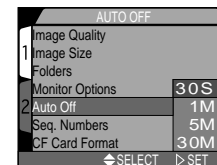

Using a 2CR5 (DL245) Battery

When powered by a six-volt 2CR5 (DL245) lithium battery, the camera may become hot if left on for an extended period. We recommend that you set "Auto Off" to five minutes or less when using a 2CR5 (DL245) lithium battery.

Sleep Mode

In sleep mode, all camera functions are deactivated and the camera itself is effectively off, consuming almost no power. The camera can be reactivated by pressing the Multi selector or any other buttons on the camera back (except TRANSFER button), by rotating the mode dial, or by pressing the shutter release button halfway. When the camera is reactivated, the green light next to the viewfinder will light, and the monitor will then turn on after a short pause.

Using an AC Adapter

When the camera is powered by the EH-21 AC adapter/battery charger (available separately), the camera will remain on for thirty minutes if no operations are performed, regardless of the setting in the "Auto Off" menu. If the camera is connected to a video device, video output will continue indefinitely after the monitor has turned off.

File Numbering: The Seq. Number Menu

When saving pictures, the camera assigns each picture a file name consisting of “DSCN” followed by a four-digit number assigned automatically by the camera. The “Seq. Number” menu controls how the camera assigns file numbers.

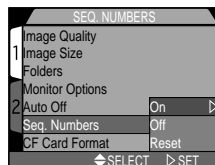

Option	Description
On	When this option is selected, the camera assigns all subsequent file numbers sequentially in ascending order, starting from the last number used. If the CF memory card is formatted or a new card inserted in the camera, file numbering will continue from the last number used. This makes it easier to keep track of images and helps prevent files from being accidentally overwritten when they are copied to the same folder on a computer.
Off	The camera does not store the last file number used. When a new file is created, numbering starts from the lowest number available.
Reset	Clears the current file number from memory. Sequential file numbering begins again from the lowest number available on the current CF memory card.

File and Folder Names

Photos created by the COOLPIX885 have names of the form “DSCNnnnn.JPG,” where nnnn is a four-digit number assigned automatically by the camera (e.g., “DSCN0001.JPG”). In place of “JPG,” movies have the extension “MOV” (e.g., “DSCN0001.MOV”). For the small picture files, “SSCN” instead of “DSCN” is assigned (e.g., “SSCN0002.JPG”). Photos and movies are stored in folders with a name consisting of a three-digit number between 100 and 999, followed by “NIKON” (e.g., “100NIKON”).

When a file number exceeds 9999 in a folder or the number of files in a folder exceeds 200, a new folder with one added to the folder number is created and image files, with sequential file numbers from 0001, will be stored in it.

CF Card Format

The CF memory card supplied with your camera is already formatted for use in the COOLPIX885. Other CF memory cards will however need to be formatted prior to use. For more information on formatting CF memory cards, see “Tutorial: First Steps: 3 Insert the CF Memory Card” (p. 47).



Storing Camera Settings: The Controls Menu

In CSM mode, the first three items in the “Controls” menu determine what camera settings remain in effect when the camera is turned off. If an item is checked, the setting in effect at the time the camera was turned off will be restored the next time the camera is turned on. Any items that are not checked will be restored to default settings when the camera is turned on.



Option	Setting Affected	Default
save	Flash setting	Auto
save	Focus mode	Autofocus
save	Exposure compensation	±0.0
Digital Zoom	Digital zoom	On

The fourth item, “Digital Zoom”, is used to turn digital zoom on and off in ATUO, SCENE and CSM mode. If it is checked, digital zoom functions normally (p. 90). If this item is not checked, digital zoom cannot be used, and pressing the **T** zoom button at the maximum optical-zoom position has no effect.

To check an item, or remove the check mark from an item that has already been checked, highlight the item and press **▶** on the Multi selector. Highlight “Done” and press **▶** on the Multi selector to put the changes into effect.

Confirming Shutter Release: The Shot Confirm Lamp Menu

If desired, the red-eye reduction lamp next to the viewfinder window can be used to let your subjects know that the shutter has been released. This can be useful when taking portraits without the flash. Shot confirmation can be turned on or off in the “Shot Confirm Lamp” sub-menu.



Option	Description
Off	Red-eye reduction lamp does not light when shutter is released (default).
On	Red-eye reduction lamp lights when shutter is released.

Photo Information and Transfer Setting: The Pic Data/Transfer Menu

The “Pic Data/Transfer” sub-menu contains options for storing information about the camera status at the time when the picture was taken as a text file and for turning on/off the transfer mark associated with pictures and movies as they are taken.

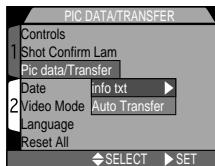

Recording Photo Information: The info. txt Sub-Menu

When “On” is selected in the “info. txt” sub-menu, a text file (“info. txt”) will be created on the CF memory card in the camera to store picture information for all subsequent images. When the contents of the CF memory card are viewed from a computer, this file, which may be found in the same folder where the images are stored, can be read with a text editor or word processor such as Simple Text or Notepad. The default setting for “info. txt” is “Off”.

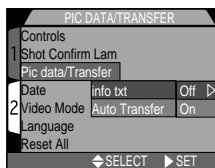

Option	Description
Off	Text-format picture information not recorded (does not affect playback photo-information display).
On	Picture information recorded in text format.

The info. txt file gives the following information about the camera settings relevant to each image in the folder:

- File number and type
- Metering mode
- Shutter speed
- Exposure compensation
- Image adjustment
- White balance
- Date of recording
- Camera type and firmware version
- Exposure mode
- Aperture
- Focal length and digital zoom factor
- Sensitivity (ISO equivalency)
- Sharpening
- Image size and quality

Images are listed in the order recorded, separated by a blank line.

Making Pictures for Transfer: The Auto Transfer Sub-Menu

When you connect the camera to a computer running Nikon View and press the TRANSFER button, any images that have been marked for transfer will automatically be copied to the computer. The transfer menu controls whether images are marked for transfer as they are taken. The following options are available:

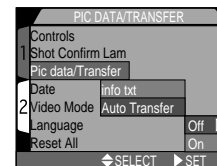

Option	Description
Off	Pictures and movies are not marked for transfer.
On (Default setting)	Pictures and movies are marked for transfer as they are taken.

Changing Transfer Status

Images already recorded to the CF memory card can be selected for transfer by pressing the TRANSFER button when the image is displayed in Full-Screen review (p. 71) or in playback mode (p. 156), or when the image is highlighted in thumbnail review or thumbnail playback. If the image is already marked for transfer, pressing the TRANSFER button will turn transfer marking off. The “Transfer” option in the playback menu can be used to select all images on the CF memory card for transfer, or to remove transfer marking from all images (p. 174).

Marking image files for transfer

Up to 999 images on a CF memory card can be marked for transfer. Image files of any file number can be transferred. To transfer 1000 or more images, use one of the following methods:

- 1) Transfer the images using Nikon View 4, not the TRANSFER button.
- 2) Transfer 999 images using the TRANSFER button, and unmark the images once they have been transferred. The mark the remaining images for transfer and press the TRANSFER button once again.

The Date Menu

The Date option is used to set the camera to the current date and time. For more information, see “Tutorial: First Steps: 5 Set the Date and Time” (p. 52).

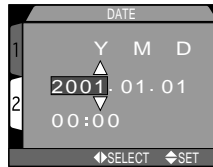

Choosing a Video Standard: The Video Mode Menu

The “Video Mode” menu is used to select the standard used for video output. Adjust this setting to match the standard used in any video device to which you connect the camera.

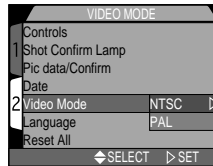

Option	Description
NTSC	Use when connecting the camera to NTSC devices.
PAL	Use when connecting the camera to PAL devices. If the video cable is connected to the camera at this setting, the monitor will turn off.

See p. 176 for more information on connecting the camera to a TV or VCR.

The Language Menu

This option is used to choose the language in which camera menus and messages are displayed. For more information, see “Tutorial: First Steps: 5 Choose a Language” (p. 51).

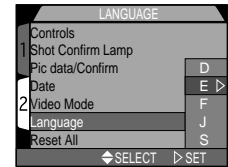

Restoring Default Settings: The Reset All Menu

The “Reset All” option in the SET-UP menu is used to restore settings for all modes to their default values.

The “Reset All” menu contains the following options:

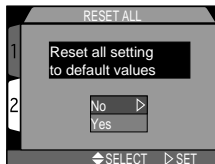

Option	Description
No	Exist menu leaving settings unchanged.
Yes	Restore settings to default values.

Choosing “Yes” restores the following options to their default values:

Setting	Default
SCENE mode	Portrait
White Balance	Auto
Metering	Matrix
Continuous	Single
BSS	Off
Image Adjustment	Normal
Image Sharpening	Auto
Lens	Normal
Image Size	Full
Image Quality	Normal
Sensitivity	Auto
Exposure Mode	P
AE Lock	Off
Exposure Compensation	0

Setting	Default
AF Area Mode	Auto
Auto-Focus Mode	Continuous AF
Focus Confirmation	MF
Auto Bracketing	Off
Noise Reduction	On
Folders	NIKON
Display Mode	On
Brightness	3
Hue	6
Auto Off	30 S
Seq. Numbers	On
Controls	All options on
Shot Confirm Lamp	Off
info. txt	Off
Auto Transfer	On
Frame Interval (Slide Show)	3 S
Transfer	On
Small Picture	640 x 480

All other settings are unaffected.

This section details settings available only in the CSM Mode. In addition to the settings discussed in the previous section, in CSM Mode the user can control the following settings by means of the mode dial and the buttons on the back of the camera:

- sensitivity (ISO equivalency)
- focus distance (manual focus)

Menus in CSM mode also give the user control over:

- White balance
- metering
- frame-advance rate
- best-shot selection
- contrast, brightness and image type
- image sharpening
- settings for optional lens converters
- exposure options
- focus options
- auto bracketing
- noise reduction

Adjusting Exposure Manually: Manual Exposure Mode

If you want to adjust the shutter speed to freeze action or to suggest motion by blurring moving objects, or if you want to modify exposure from the value suggested by the camera, choose manual exposure mode by selecting "M" in "EXPOSURE OPTIONS > Exposure Mode" sub-menu in CSM shooting menu.

Choosing an Aperture

In manual exposure mode, aperture is chosen by pressing ◀/▶ on the Multi selector while holding down the  button.

- 1 Press ◀ for maximum aperture (small f number), ▶ for minimum aperture (large f number).

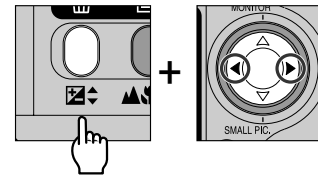

- 2 Confirm aperture setting in monitor.

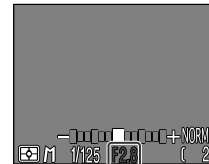

Note on minimum aperture

Filter is applied to adjust the light entering the camera when the aperture is set to its minimum with the COOLPIX885. Because of this, the minimum aperture setting may not yield wider depth-of-field as expected from the aperture value displayed in the monitor.

If the aperture you have selected would result in the picture being over- or under-exposed, the aperture value displayed in the monitor will flash when the shutter release button is pressed halfway.

Choosing a Shutter Speed

In manual exposure mode, shutter speed is chosen by pressing ▲/▼ on the Multi selector while holding down the  button. Options range from 8 sec. to 1/1000 sec. in increments equivalent to 1 EV (one step). In addition, a shutter speed of “BULB” up to 60 sec. is available for long-time exposures.

1 Press ▲ for slower shutter speeds, ▼ for faster shutter speeds.

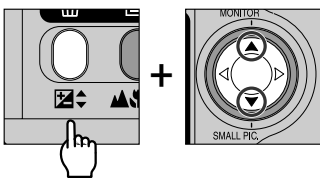

2 Confirm shutter speed in monitor.

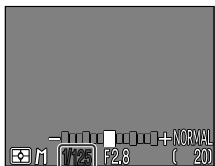

In manual exposure mode, the amount the picture would be over- or underexposed at the selected combination of aperture and shutter speed is displayed in the monitor.



Display shows values between -2 and +2 EV in increments of 1/3 EV.

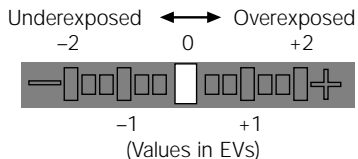

Choose high shutter speed to freeze action, low shutter speed to suggest movement by blurring moving objects.

Long-time exposure (up to 60 sec.)

- When the shutter speed is set to “BULB” (manual exposure mode only), the shutter will remain open while the shutter release button is pressed (maximum exposure 60 sec.). To reduce blurring caused by camera shake, we recommend that you use a remote shutter release (the MC-EU1 Remote Cord, available separately, functions as a remote shutter-release cable) and a tripod.
- At default setting, the noise reduction (p. 154) is automatically set when the shutter speed is slower than 1 sec. in the long-time exposure.

Shutter speed limitations

- At a “CONTINUOUS” setting of “Ultra HS” (p. 139), the lowest available shutter speed is 1/30 sec. At setting of  movie (p. 89), shutter speed cannot be set to a value slower than 1/15 sec. “BULB” is only available at a setting of “Single” (p. 139).
- Note that if the shutter is open for more than 1/4 sec. at any setting, mottling (noise) may appear in the final picture. At speeds of 1/4 sec. or slower, the shutter speed indicator in the monitor turns yellow.
- At default setting, the noise reduction (p. 154) is automatically set when the shutter speed is slower than 1 sec. in CSM shooting mode.

Reacting Faster to Light: Sensitivity (ISO Equivalency)

“Sensitivity” is a measure of how quickly your camera reacts to light. The higher the sensitivity, the less light needed to make an exposure, allowing the same exposure to be achieved with faster shutter speeds or smaller apertures. In a film camera, sensitivity is a characteristic of the film, not the camera. The ISO ratings you see on packages of film are a measure of their sensitivity—the higher the ISO rating, the more sensitive the film. Higher sensitivity is achieved by altering the chemical composition of the film, causing a random pattern called “grain”, to appear in the final picture. In a digital camera, increased sensitivity has a similar effect: higher sensitivities allow higher shutter speeds, at the expense of mottling, or “noise” (the digital equivalent of film “grain”) appearing in the final image.

Adjusting Sensitivity

In AUTO mode, the camera sets sensitivity automatically in response to lighting conditions. When the mode dial is set to CSM, you can choose a fixed value for sensitivity from four possible settings. Sensitivity is set by pressing the zoom button while holding down the  button.

- 1 Press T for increased sensitivity, W for decreased sensitivity; At setting of 400, press T to select setting of AUTO

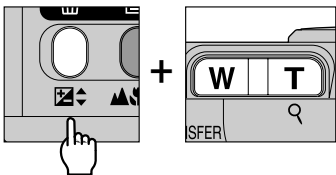

- 2 Sensitivity displayed in monitor

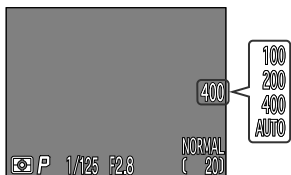

The following settings are available

Setting	Description
AUTO (default)	Equivalent to setting of 100 under normal conditions; when lighting is poor, however, camera automatically raises sensitivity to compensate. ISO icon appears in monitor only when sensitivity raised above 100.
100	Approximately equivalent to ISO rating of 100.
200	Approximately equivalent to ISO rating of 200.
400	Approximately equivalent to ISO rating of 400.

Sensitivity can also be set using the “ISO” item in the CSM shooting menus (p. 147).

- A slight amount of mottling (noise) may appear in pictures taken at settings other than 100.
- Changes to sensitivity have no effect in AUTO or SCENE operating modes.

Focusing at a Preset Distance: Manual Focus

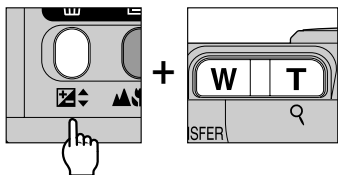

In CSM mode, manual focus can be used in place of autofocus for situations in which you know the distance to the subject. Focus distance can be selected from forty-nine preset distances, ranging from 0.03 m (0.10 ft.) to infinity at widest angle, by pressing the zoom buttons while holding down the  button.

- 1 Press T to increase the focus distance to maximum of infinity (InF), W to decrease.



- 2 Focus distance is displayed in monitor.





The focus distances available depend on the focus mode setting (p. 92). Note that the focus distances of 0.03-0.3 m (0.10-1 ft.) are only available at  (macro close-up) and  (macro close-up + self-timer) at widest angle.

The value displayed for manual focus-distance is the approximate distance from the front of the lens. The actual focus distance may differ slightly from the value shown; check focus in the monitor before shooting.

- Manual focus can be canceled by pressing the  button.

Tips on manual focus

- To use the self-timer in combination with manual focus, select a focus mode of  (autofocus + self-timer) or  (macro close-up + self-timer) before choosing the focus distance.
- The flash can be used while manual focus is in effect. This makes it possible to combine the flash with a focus setting of infinity.
- The units used for manual focus can be selected from meters or feet using the "Distance Units" sub-menu in the SETUP menu (p. 151).

Using CSM Shooting Menu Options

In CSM shooting mode, adjustments to some shooting options are made from the camera menus (no menu is available in AUTO, SCENE and movie mode). The CSM shooting menu can be used to adjust camera settings for specific subjects or situations—for example, when photographing very bright subjects, or when taking pictures under fluorescent lighting.

To view the CSM shooting menu:

1

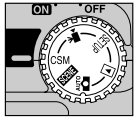

Select CSM (CSM shooting menu).

2

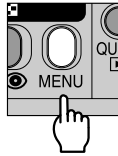

Press MENU button to display CSM shooting menu.

See p. 30 for more information on "Using Camera Menus".

The Shooting menu contains two pages of advanced shooting options:

SHOOTING MENU 1

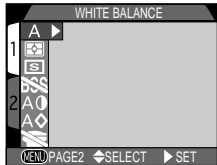

A	WHITE BALANCE	P. 135-136
	METERING	P. 137-138
	CONTINUOUS	P. 139-140
	BEST SHOT SELECTOR	P. 141
A	IMAGE ADJUSTMENT	P. 142-143
A	IMAGE SHARPENING	P. 144
	LENS	P. 145-146

SHOOTING MENU 2



QUAL	IMAGE SIZE & QUALITY	P. 103-107
ISO	SENSITIVITY	P. 147
EXP.	EXPOSURE OPTIONS	P. 148-149
FOCUS	FOCUS OPTIONS	P. 150-151
	AUTO BRACKETING	P. 152-153
NR	NOISE REDUCTION	P. 154
	CF CARD FORMAT	P. 117

Keeping Colors True: The White-Balance Menu

What is "White Balance"?

The color of the light reflected by an object depends on the color of the light source. The human brain is able to detect and compensate for such changes in color, with the result that a white object will look white to humans whether viewed in sunlight, under overcast skies, or indoors under incandescent or fluorescent lighting. To a camera, however, the "whites" produced by these different sources of light vary in color, some being slightly blue and others yellow or red. A digital camera can adjust colors according to lighting so that colors that appear white to the human eye also appear white when viewed in the final picture. This adjustment is called "white balance."

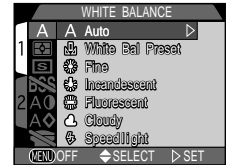

Choosing a White Balance Setting

In CSM shooting mode, white balance can be chosen from the white-balance menu (in other modes, white balance is adjusted automatically according to the type of scene). The following options are available:



Option	Description
A Auto	White balance automatically adjusted to suit lighting conditions. Best choice in most circumstances.
White Bal Preset	White object used as reference to set white balance under unusual lighting conditions.
Fine	White balance adjusted for direct sunlight.
Incandescent	Use when taking pictures indoors under incandescent light.
Fluorescent	Use when taking pictures indoors under fluorescent light.
Cloudy	Use for pictures taken outdoors under overcast skies.
Speedlight	White balance adjusted to match light produced by flash.

Fine-Tuning White Balance

At settings other than “A” (auto) and  (preset), white balance can be “fine-tuned” by highlighting the desired setting and selecting an adjustment from a sub-menu. A adjustments can be made in the range of +3 to -3 or, in the case of  (fluorescent), by selecting the type of bulb from the following sub-menu:

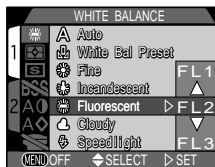

Option	Description
FL1	W (default)
FL2	N
FL3	D

Raising white balance gives images a blue, “cold” cast; lowering white balance makes pictures appear “warmer”—that is, slightly yellow or red. After selecting the desired adjustment, press  on the Multi selector to put your choice into effect.

— Preset White Balance —

Preset white balance is used to adjust white balance when shooting under mixed lighting or to compensate for light sources with a strong color cast (for example, to make pictures taken under a lamp with a red shade look as though they had been taken under white light). When  (White Bal Preset) is selected from the white-balance menu, the camera will zoom in and the menu shown at right will be displayed in the monitor.



Option	Description
Cancel	Recalls the most recent setting for preset white balance from memory and sets white balance to this value.
Measure	To measure a new value for white balance, place a white object, such as a piece of paper, under the lighting that will be used in the final picture. Frame this object so that it fills the square in the center of the menu shown above. Highlight “Measure” and press the Multi selector to the right to measure a new value for preset white balance (camera will zoom out and shutter will be released, but no picture will be recorded).

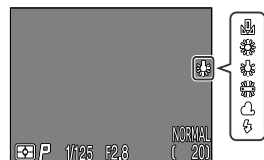



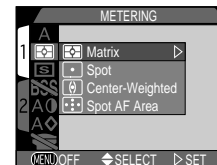

At setting other than AUTO, the current white-balance setting is indicated by an icon in the monitor.

Measuring Light: The Metering Menu

The “metering method” is the method your camera uses to measure light when determining exposure. In CSM shooting mode, “METERING” menu offers a choice of four metering methods:





Method	How It Works	When to Use It
 Matrix	Exposure calculated by comparing measurements from 256 areas of frame with library of typical compositions, producing best possible setting for entire frame.	Best choice in most circumstances.
 Spot	Camera measures light in area in center of frame occupying roughly 1/32 of total, shown by square in center of monitor.	Ensures that subject in metering target will be correctly exposed even when background very bright or very dark. Can be used in combination with AE hold (p. 148).
 Center-Weighted	Camera measures light in entire frame but assigns weight of 80% to area in center of frame occupying roughly 1/4 of total.	Classic meter for portraits; preserves background details while letting lighting conditions at center of frame determine exposure. Selected automatically when digital zoom (p. 90) is used. Can be used in combination with AE hold (p. 148).
 Spot AF Area	Camera measures light in current focus area only.	Use to link spot metering to correctly selected focus area when manual or auto focus-area selection is in effect. Equivalent to “Matrix” when focus-area selection (p. 150) is off; equivalent to “Spot” when manual focus (p. 151) is used.



The metering method is shown by icons in the monitor.

Auto Exposure hold

Spot or center-weighted metering sets exposure for the subject in the center focus area when the shutter release button is pressed halfway. If your subject is not in the center focus area, exposure will be set for an object in the background, with the result that your main subject may be over- or under-exposed. Using AE hold, you can meter your main subject and then adjust the composition before taking the picture.

- 1 Set metering to  (spot) or  (center-weighted).
- 2 Position the subject in the center of the frame and press the shutter release button halfway to lock focus (p. 61) and exposure.

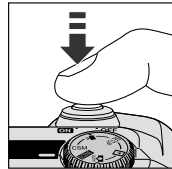
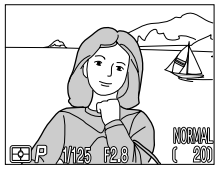

- 3 Keeping the shutter release button held halfway, recompose your picture; press the shutter release button the rest of the way down to shoot.

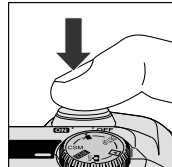
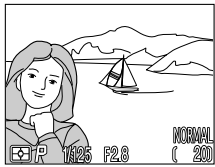



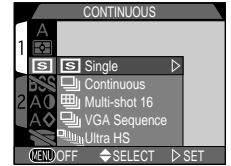

Spot AF Area metering can be used in combination with focus-area selection (p. 150) to measure lighting in one of five focus areas, allowing you to meter an off-center subject without using auto exposure lock.

Taking Pictures in a Sequence: The Continuous Menu

The “Continuous” menu determines whether the camera takes one picture each time the shutter release button is pressed, or records a continuous sequence of pictures while the shutter release button is held down.



Option	Description
 Single	Camera records one picture each time the shutter release button is pressed all the way down.
 Continuous	Camera records pictures at a rate of about three photos every two seconds while the shutter release button is held all the way down. This setting can be used to capture fleeting expressions on a portrait subject, or to photograph a subject that is moving unpredictably. Not available at image quality setting of HI.
 Multi-shot 16	Camera takes sixteen consecutive “thumbnail” images and combines them into a collage. This option is only available when image size is set to FULL.
 VGA Sequence	Camera takes series of pictures 640 x 480 pixels in size. Image quality (p. 104) is set to NORMAL, allowing pictures to be taken at approximately two frames per second while shutter release button is held down.
 Ultra HS	Camera takes seventy pictures 320 x 240 pixels in size (QVGA) each time shutter release button is pressed. Image quality (p. 104) is set to NORMAL allowing pictures to be taken at approximately thirty frames per second. Each sequence of pictures is saved in separate folder automatically created by camera. Folder name is composed of “N_” followed by three-digit number assigned in ascending order by camera.

- At settings other than Single, the flash is set to “Off” (🚫) and will not fire even when lighting is poor (p. 98).
- At settings other than Single, the focus, exposure and white-balance settings used for the first image apply to all other images in the same series.
- Setting of “Ultra HS” only takes effect when the monitor is on. If the monitor is turned off, the camera will revert to a setting of “Single” until the monitor is turned on.

The Memory Buffer

The camera is equipped with a memory buffer for temporary storage of photos during shooting, allowing you to take several pictures in succession without waiting for the images to be transferred to the CF memory card. The number of images that can be stored in the buffer depends on the quality and size of the images. When the buffer becomes full, an hourglass icon (🕒) will be displayed in the monitor until enough data have been transferred to the card to allow more pictures to be taken. More pictures can be taken as soon as enough memory becomes available in the buffer. At a setting of "Continuous" or "VGA Sequence", you can continue to take pictures as long as the shutter release button is held down, although the rate at which pictures are taken will drop when the buffer fills up.

Note: Noise Reduction in Multi-shot 16 or Ultra HS

When Multi-shot 16 or Ultra HS mode is set, Noise Reduction (p. 154) is automatically turned off. To use Noise Reduction after taking pictures with Multi-shot 16 or Ultra HS, turn Noise Reduction on again.

During Recording

While images are being transferred from the buffer to the CF memory card for permanent storage, the green light next to the viewfinder will blink. Do not eject the CF memory card, or remove or disconnect the power source until the light has stopped blinking. Removing the card or cutting power in these circumstances could result in loss of data. Be sure that the camera is off before you remove the CF memory card.



At settings other than "Single", the current "continuous" setting is indicated by an icon in the monitor.

Getting Sharper Pictures: The BSS (Best-Shot Selector) Menu

"Best-Shot Selector" (BSS) is used when inadvertent camera movement could cause blurring. It is most effective in situations in which inadvertent camera movement can produce blurred pictures, for example when:



- the camera is zoomed in
- you are using macro close-up to take pictures at ranges of less than 30 cm (1 ft.)
- the flash can not be used although lighting is poor (for example, the subject is outside the range of the flash or you want to capture natural lighting under low-light conditions)

BSS may not produce the desired results with a moving subject or if you change the composition while the shutter release button is pressed all the way down.

The BSS menu contains the following options:

Option	Description
Off	BSS off; camera functions normally.
On	Camera takes photos as long as the shutter release button is held down, to a maximum of ten. These images are then compared and the sharpest photo (the photo with the highest level of detail) saved to the CF memory card. The flash is turned off, and focus, exposure, and white balance are determined by the first picture in the series.

Restrictions on BSS

BSS is not available at "continuous" settings other than Single or an image quality setting of HI. Selecting either of these options automatically cancels BSS.

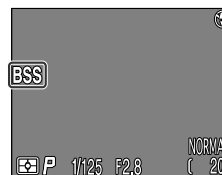

When BSS is on, a BSS icon appears in the monitor.





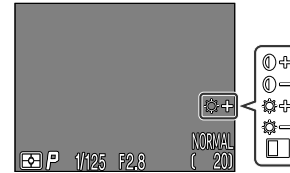
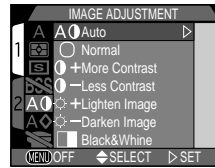

Contrast, Brightness and Image Type: The Image Adjustment Menu

When you take a picture, the camera automatically performs image compensation for optimal brightness and contrast before recording the picture to the CF memory card. The image-adjustment sub-menu gives you control over this image compensation operation, allowing you to control not only brightness and contrast, but also to produce monochrome images. The following options are available:



An image-adjustment icon appears in the monitor at settings other than “Normal” and “Auto”.

- Only one image adjustment setting can be used at a time. Selecting a new image-adjustment option cancels the previous setting.
- The effects of adjustments to brightness and contrast are not visible in the monitor.

Option	Description
A  Auto	Camera adjusts brightness and contrast for optimal results; adjustment performed differs from image to image (this setting is automatically selected in AUTO mode).
 Normal	Camera performs same standard brightness and contrast adjustment on all images (default setting). This setting is recommended for images that will later be retouched on a computer.
 + More Contrast	Image processed to increase difference between light and dark areas.
 - Less Contrast	Image processed to reduce difference between light and dark areas.
 + Lighten Image	Increase brightness of mid-tones in image, without affecting detail in highlights or shadows. This setting can be used on images that will be output on computer monitor or printer if device tends to produce images that are too dark.
 - Darken Image	Decreases brightness of mid-tones in image, without affecting detail in highlights or shadows. This setting can be used on images that will be output on computer monitor or printer if device tends to produce images that are too bright.
 Black & White	Image converted to black and white. Black-and-white images require same amount of memory as color images, but show higher level of detail. When this option is in effect, view through lens shown in monitor is in black and white. White-balance settings (p. 135) and digital zoom (p. 90) cannot be used while this option is in effect.

Making Edges More Distinct: The Image Sharpening Menu

When you take a picture, the camera automatically outlines edges, making the image appear sharper. In auto mode, the image-sharpening menu gives you control over the amount of sharpening performed (in scene mode, the camera automatically adjusts sharpening according to the subject). The following options are available:

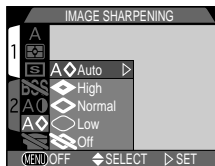

Option	Description
A Auto	Camera sharpens edges for optimal results; adjustment performed differs from image to image.
High	Image processed to increase sharpness, making edges more distinct.
Normal	Camera performs same standard level of sharpening on all images.
Low	Amount of sharpening reduced below normal level.
Off	No sharpening performed.

The effects of sharpening are not visible in the monitor.



At settings other than "Auto" and "Off", the current image-sharpening setting is shown by an icon in the monitor.

Setting for Optional Lens Converters: The Lens Menu

When the UR-E4 step-down ring lens adapter (available separately) is attached to the camera lens, optional lens converters for wideangle, telephoto and fisheye photography can be used with the COOLPIX885. An adapter for taking pictures of film positives is also available. Each of these converters is adapted to a particular combination of settings, including focus mode, zoom position and metering method. Using the lens sub-menu, you can select combinations of setting suited to particular lens converters.

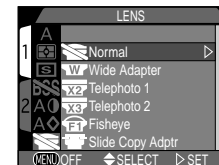



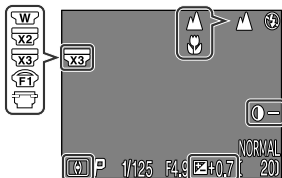

Option	Description
Normal	No modifications are made to settings. Use this option when no lens converter is attached.
W Wide Adapter (for WC-E24 and WC-E63 wideangle converters)	<ul style="list-style-type: none"> • Camera zooms out to widest angle (p. 90) • Flash disabled (p. 98) • Zooms in to maximum optical-zoom position, adjustable after setting (p. 90)
X2 Telephoto 1 (for TC-E2 2X telephoto converter)	<ul style="list-style-type: none"> • Camera zooms in to maximum optical-zoom position (p. 90) • Optical zoom (p. 90) adjustable between maximum to middle position. • Flash disabled (p. 98)
X3 Telephoto 2 (for TC-E3ED 3X telephoto converter)	<ul style="list-style-type: none"> • Zoom fixed at maximum optical zoom position (p. 90) • Flash disabled (p. 98)
F1 Fisheye 1 (for FC-E8 fisheye converter)	<ul style="list-style-type: none"> • Zoom fixed at widest angle (p. 90) • Focus fixed at infinity (p. 93) • Metering method fixed at center-weighted (p. 137) • Flash disabled (p. 98) • Self-timer can be set (p. 95)
Slide Copy Adptr (for ES-E28 slide-copying adapter)	<ul style="list-style-type: none"> • Zoom set to 1.2X digital zoom and adjustable between 1.2-4X (p. 90) • Focus mode fixed at macro close-up (p. 93) • Flash disabled (p. 98) • Image adjustment set to -Less Contrast (p. 142) • Exposure compensation set to +0.7 EV, adjustable (p. 100) • Self-timer can be set (p. 95) • Take picture while the monitor is on

For details of use and handling, refer to the documentation provided with your lens converter.



Lens converter icon appears in the monitor at settings other than “Normal”.

Modifying Sensitivity from a Menu: The Sensitivity Menu

The sensitivity menu mirrors the sensitivity (ISO equivalency) value set with the  button in combination with the zoom button (p. 130). As with the  button, sensitivity can be set to AUTO, 100, 200 or 400. Choosing a new sensitivity value from the “Sensitivity” sub-menu changes the value selected with the  and zoom button, while changing the sensitivity value with the  button changes the value selected in the “Sensitivity” sub-menu.

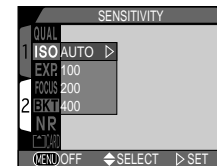

Exposure Options

The exposure options sub-menu provides control over exposure.

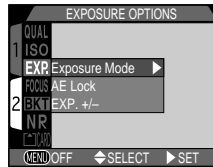

— Exposure Mode —

When the mode dial is set to CSM, you can choose the exposure mode, either “P” or “M”, from the “Exposure Mode” sub-menu. For more information on M mode, see “Adjusting Exposure Manually: Manual Exposure Mode” (p. 127).

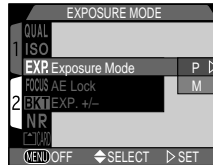

— Taking Multiple Pictures with the Same Exposure: AE Lock —



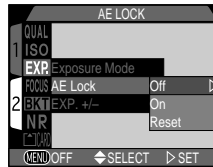

When taking a series of pictures that you will later join into a single image (for example, when taking shots that will later be joined to form a panorama or 360° virtual-reality image), you will need to use the same exposure, sensitivity, and white-balance settings for each of the images in the series. This is possible using the AE-lock menu.



Option	Description
Off	Restores normal exposure, sensitivity and white balance.
On	First picture taken after “On” is selected sets exposure for all subsequent pictures. If white balance is set to “A” (auto), white balance for first picture applies to all other pictures in series. While AE lock is in effect, flash will be set to “Off” (🚫).
Reset	Clears existing exposure, sensitivity and white balance settings. First picture taken after this option is selected sets exposure, sensitivity and auto white balance for all subsequent pictures.

While AE lock is in effect, “AE-L” (AE Lock) and “WB-L” (White-Balance Lock) icons appear in the monitor. If “Reset” is chosen or white balance, focus mode, shutter speed or aperture adjusted, these icons will turn yellow to indicated that exposure will be reset with the next shot.

— Modifying Exposure Compensation from a Menu: Exp. +/- —

The “Exp. +/-” item in the EXPOSURE OPTIONS menu mirrors the exposure compensation value set with the  button and Multi selector (p. 100). As with the  button, exposure compensation can be set to values between +2.0 EV and –2.0 EV in increments of 1/3 EV. Choosing a new exposure compensation value from the “Exp. +/-” sub-menu changes the value selected with the  button, while changing exposure compensation with the  button changes the value selected in the “Exp. +/-” sub-menu.

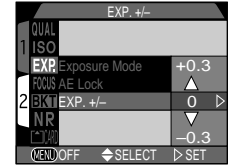

Focus Options

The focus options sub-menu provides control over focus settings.

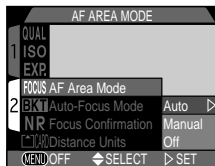
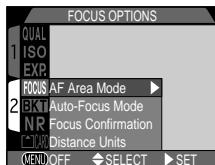

— Focus-Area Selection: AF Area Mode —

This setting determines how the camera will choose the focus area in CSM mode. The following options take effect while the monitor is on (when the monitor is off or digital zoom is activated, AF Area Mode is automatically set to Off):

Option	Description
Auto	Camera automatically selects focus area containing subject closest to camera. Active focus area displayed in red when shutter release button pressed halfway. This setting is useful when you have little time to compose pictures.
Manual	User selects focus area manually (p. 101). This option can be used in place of focus lock when subject is not at center of final composition.
Off	Center focus area is used. No focus areas appear in monitor. This option can be used in combination with focus lock to focus on off-center subject (p. 61).

— Auto-Focus Mode —

In CSM mode, you can choose the autofocus mode used when the monitor is on (when the monitor is off, single autofocus is used, regardless of the setting in the autofocus mode sub-menu). See “Beyond Point and Shoot: Focusing Near and Far” for more information on autofocus (p. 92).

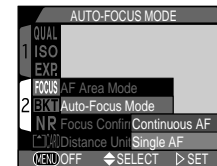

Option	Description
Continuous AF	Camera adjusts focus continuously; focus is locked when shutter release button is pressed halfway and remains locked as long as it is held in this position (p. 61).
Single AF	Camera focuses when shutter release button is pressed halfway; focus is locked as long as shutter release button is held in this position. Choose this option to save battery power.

— Focus Confirmation —

Use focus confirmation when you want to know exactly what areas of the frame will be in focus before you take the final picture. Focus confirmation affects only the view through the lens shown in the monitor; no indicators of focus appear in the final picture.

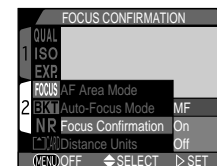

Option	Description
MF (Manual Focus)	Objects that are in focus will be sharply outlined in monitor when manual focus is used (p. 132).
On	Objects that are in focus will be sharply outlined in monitor in all focus modes.
Off	No indication of focus is given.

— Distance Units —

In this sub-menu, you can choose the units used when displaying manual focus distance (p.132). The options available are meters (m) or feet (ft).

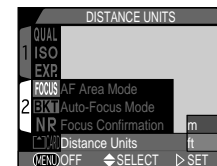

Auto Bracketing

In situations where it might be difficult to obtain a proper exposure, auto bracketing lets you shoot the same subject at three or five different exposures. In WB Bracketing, the white balance is bracketed in three shots.

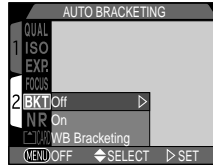

Option	Description
Off	Bracketing is off and normal exposure control is used.
On	Auto bracketing is performed with the selected number of bracketing shots and with a compensated EV value offset from the automatically metered exposure.
WB Bracketing	The white balance is bracketed when you press the shutter release button fully giving three shots made up of one with the selected white balance, a reddish image and a bluish image. <ul style="list-style-type: none"> The time required to save bracketed images to the CF memory card is three times that required for a normally recorded image.

Note: When setting auto bracketing or white balance bracketing

Before setting auto bracketing or white balance bracketing, make sure to turn Noise Reduction (p. 154) off.

— On —

Each time you press the shutter release button, either three or five shots are taken ranging from over exposed EV values to under exposed EV values. When photographing a high-contrast image, the image with the desired exposure can be selected from the set of bracketed shots.

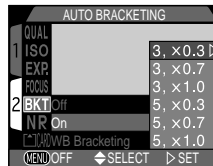

Number of shots, compensated EV value	Bracketing order
3, x 0.3	+0.3, 0, -0.3
3, x 0.7	+0.7, 0, -0.7
3, x 1.0	+1.0, 0, -1.0
5, x 0.3	+0.7, +0.3, 0, -0.3, -0.7
5, x 0.7	+1.3, +0.7, 0, -0.7, -1.3
5, x 1.0	+2.0, +1.0, 0, -1.0, -2.0

To perform auto bracketing or white balance bracketing in Continuous or VGA Sequence mode (p. 139), hold down the shutter release button fully. A selected number of consecutive shots are taken, after which the sequence stops automatically.

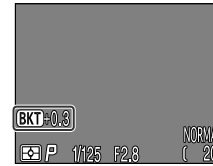

The exposure compensation indication  along with the compensated EV value for the next shot are displayed in the monitor when the bracketing is set.

— WB Bracketing —

White balance is bracketed when you press the shutter release button fully, giving three shots made up of one shot with the selected white balance, one reddish image and one bluish image.

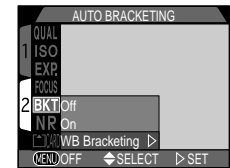

When you select white balance bracketing, the **BKT WB** (White Balance Bracketing indication) appears in the monitor.

Notes: Auto Bracketing and White Balance Bracketing

- Bracketing cannot be set in Multi-shot 16, Ultra HS (p. 139), Best Shot Selector (p. 141), AE Lock (p. 148) or Noise Reduction mode (p. 154).
- White balance bracketing cannot be set in Continuous mode other than Single (p. 139), Best Shot Selector, AE Lock or Noise Reduction mode.

Noise Reduction

When the camera is set for long time exposures, noise in the form randomly spaced bright-colored pixels will appear. The longer the exposure, the more this effect is apparent. The noise reduction setting can be used to minimize this effect.

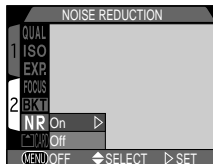

Option	Description
On	The effect of noise on the recorded image is minimized.
Off	Noise reduction is canceled and normal exposure control is used.

Note: Time taken to save an image to the CF memory card

When the noise reduction function is on, the time taken to save a picture to the CF memory card is approximately doubled.

Note: Multi-shot 16 and Ultra HS mode

When Multi-shot 16 or Ultra HS mode is set (p. 139), Noise Reduction is automatically turned off.

At default setting, the noise reduction is automatically set when:

- the shutter speed is slower than 1/4 sec. in scene mode
- the shutter speed is slower than 1 sec. in CSM shooting mode
- the shutter speed is slower than 1 sec. in the long time exposure

This section details the operations that can be performed when the mode dial is set to . It is divided into the following three sub-sections shown:

Basic Playback pp. 156-162

This section covers operations that can be performed using the Multi selector and the buttons on the back of the camera, including:

- playback of pictures stored on the CF memory card, whether singly or in “contact sheets” of nine or four thumbnail images
- movie playback
- deleting individual pictures
- zooming in on images for enlarged views that show fine details
- marking individual images for transfer to a computer
- playback of Small Pictures

The Playback Menu..... pp. 163-175

Read this section for a description of the operations that can be performed in the playback menu:

- deleting multiple pictures
- selecting a folder for playback
- “slide shows,” or automatic sequential playback of the pictures stored on the CF memory card
- protecting pictures from being deleted
- hiding images
- creating electronic “print orders” in Digital Print Order Format (DPOF)
- marking all pictures for transfer to a computer
- selecting the Small Picture size

Television Playbackp. 176-177

Learn how to connect your camera to a video device for playback on a television set.





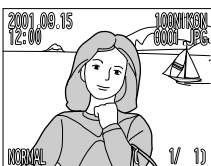
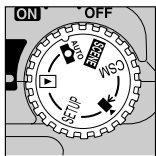

Basic Playback









When the mode dial is turned to , the camera enters playback mode with the most recent picture displayed in the monitor. This section covers the operations that can be performed in playback mode using the Multi selector and buttons on the back of the camera.



Single-Image Playback

In single-image playback, you can perform the following operations:

To	Press	Description
View other pictures		Press ◀ to view images recorded before the current picture or small picture, and ▶ for images recorded after or small picture. Hold it down to scroll rapidly to desired picture.
Hide picture information/turn monitor off (p. 158)		Press ▲ to hide picture information. Press again to turn off the monitor display. Press yet again to display picture information.
Create a Small Picture (p. 77)		Press ▼ to create Small Pictures for distribution by e-mail and the Web.
Play movie (p. 160)	QUICK 	If the current image is marked with a  icon to show that it is a movie, pressing the QUICK  button starts movie playback. Press again to pause playback.
Select current picture for transfer to computer	TRANSFER	Images marked for transfer to a computer are indicated by a  icon. To select the current image for transfer, press the TRANSFER button. If the current image is already selected for transfer, pressing the TRANSFER will deselect it.

To	Press	Description
Delete current picture		A confirmation dialog will be displayed. Press ▲/▼ on the Multi selector to highlight the option and ▶ to select. <ul style="list-style-type: none"> • Select "Yes" to delete photo • Select "No" to keep photo without deleting
View multiple images (p. 162)	 	Press the  button to display a set of up to nine thumbnail images.
Zoom in on current picture (p. 161)	 (T)	Press the Q button to magnify center of picture to fill monitor (note that zoom cannot be used with movies). While photo is zoomed in, use the Multi selector to view other parts of the image. To cancel zoom, press W button.
Display playback menu (p. 163)	MENU	Press the MENU button to display or hide the playback menu.
View picture information (p.158)	 	Press the  button to display picture information.

Playback Tips

In single-image playback, pictures are displayed briefly at low resolution while being read from the CF memory card. This makes it possible to scroll rapidly through the pictures in memory without waiting for each image to be displayed at full resolution.

To scroll quickly to a particular frame number without viewing the intervening pictures, press and hold **◀/▶** on the Multi selector. The picture displayed will not change, but the frame number displayed at the bottom right corner of the monitor will increase or decrease rapidly. Release the Multi selector when the desired frame number is reached.

The first and last pictures in memory are linked. Pressing **◀** on the Multi selector when the first picture in memory is displayed will take you to the last picture. Pressing **▶** on the Multi selector when the last picture is displayed takes you to the first picture.

Hide Picture Information and Turning Monitor Off

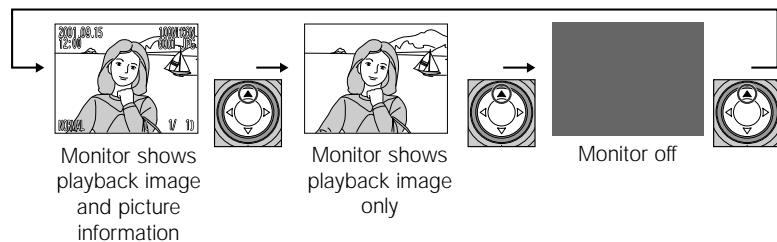

Viewing Photo Information

Photo information superimposed on pictures displayed in single-image playback. There is a total of five pages of information for each photo. Press the (▲🌸📷) button to cycle through picture information as follows:

Page 1 → Page 2 → Page 3 → Page 4 → Page 5 → Page 1.

Page 1	Page 2	Page 3
1 2001.09.15	CAMERA : E886	SPEED LIGHT : ON
2 12:00	FIRM VER : E886V1.0	IMG ADJUST : AUTO
3	METERING : MATRIX	SENSITIVITY : AUTO
4	MODE : P	WHITEBAL : AUTO
5	SHUTTER : 1/125	SHARPNESS : AUTO
6	APERTURE : F2.8	DIGITAL TELE: X1.00
7	EXP +/- : 0.0	CONVERTER : OFF
8	FOCAL LENGTH : 18.2mm	FILE SIZE : 713KB
9	FOCUS : AF	
10		

- | | | |
|--|---------------------------------------|--------------------------------|
| 1 Date of recording | • Camera type | • Flash status |
| 2 Time of recording | • Firmware version | • Image adjustment |
| 3 Image size | • Metering method | • Sensitivity (ISO equivalent) |
| 4 Image quality | • Exposure mode | • White balance |
| 5 Folder | • Shutter speed | • Sharpening |
| 6 File number and type | • Aperture | • Digital zoom |
| 7 Transfer icon | • Exposure compensation | • Lens-converter status |
| 8 Print-order icon | • Focal length | • File size (kilobytes) |
| 9 Protect icon | • Focus mode or manual focus distance | |
| 10 Frame number/total number of frames visible in current folder | | |

Page 4 (histogram)

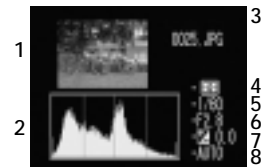

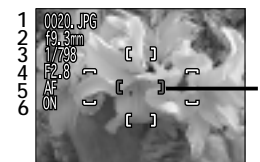

- Thumbnail preview (flashing border marks image highlights, or brightest areas of image)
- Histogram (shows distribution of tones in image: horizontal axis gives pixel brightness, with dark tones to left and bright tones to right, while vertical axis shows number of pixels of each brightness in image)
- File number and type
- Metering method
- Shutter speed
- Aperture
- Exposure compensation
- Sensitivity (ISO equivalent)

Page 5 (focus confirmation)





- File number and type
- Focal length
- Shutter speed
- Aperture
- Focus mode or manual focus distance
- Noise reduction
- Focus confirmation (portions of image in focus sharply outlined; active focus area shown in red)

Movie Playback

In single-image playback, movies are indicated by a  icon in the lower left corner of the display. Movie playback is controlled by the QUICK  button.



Operation	Function
QUICK 	Start movie. While movie is in progress, press to pause movie; press again to resume movie playback. When movie ends, first frame of movie will be displayed and normal playback will resume.
	While movie is paused: rewind movie one frame.
	While movie is paused: advance movie one frame.

Zoom

Use the Q (T) button to zoom in on pictures displayed in single-image playback (zoom cannot be used with movies and small picture files).

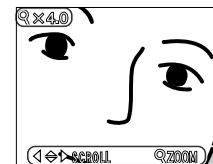

Operation	Function
Q (T) Press	Zoom picture in. Zoom increases each time button is pressed to maximum of 4.0X. While image is zoomed in, Q indicator and zoom factor are displayed in monitor
W Press	Cancel zoom.
	Scroll to another area of image.





To use the Multi selector to view other pictures in memory, first cancel zoom by pressing the **W**.

The Playback Menu

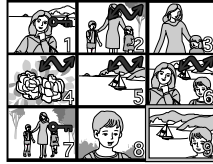
Viewing Multiple Images: Thumbnail Playback

Pressing the  button in single-image playback displays a menu of nine thumbnail images, where you can select pictures or movies for viewing, delete images, and mark images for transfer to a computer.



To	Press	Description
Highlight images		Press ▲/▼/◀/▶ on the Multi selector to highlight a thumbnail.
View highlighted image at a larger size		Press the  button once to view a menu of four thumbnail images. Press again to view highlighted thumbnail full screen. Small pictures are displayed with a grey frame.
Delete highlighted picture		A confirmation dialog will be displayed. Press ▲/▼ on Multi selector to highlight option, press ▶ to select. <ul style="list-style-type: none"> • Select "Yes" to delete picture • Select "No" to return to thumbnail playback screen without deleting the picture
Select highlighted photo for transfer to computer	TRANSFER	Images marked for transfer to a computer are shown by a  icon. To select the current image for transfer, press the TRANSFER button. If the current image is already selected for transfer, pressing the TRANSFER button will remove transfer marking.

The playback menu contains options for deleting images and print-orders, for protecting images from deletion, and for playing images back one after the other in automatic "slide shows." You can also create a digital "print order" for printing photographs on any device compatible with the Digital Print Order Format (DPOF), and select all images on the CF memory card for transfer to a computer.

To view the playback menu:

1

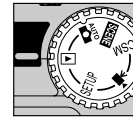

Select 



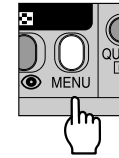



2

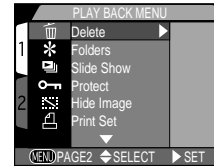

Press **MENU** button to display playback menu

Playback menu 1



	Delete	P. 164
	Folders	P. 167
	Slide Show	P. 168
	Protect	P. 170
	Hide Image	P. 171
	Print Set	P. 172

Playback menu 2

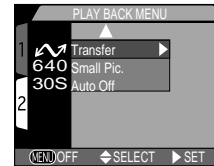

	Transfer	P. 174
640	Small Picture	P. 175
30S	Auto Off	P. 115

See p. 30 for more information on using camera menus.

Deleting Pictures and Print Orders: The Delete Menu

Using the options in the “Delete” menu, you can:

- delete selected pictures
- delete all pictures
- delete the current print order (p. 172)

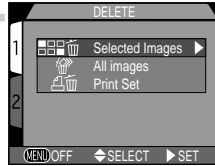

— Deleting Selected pictures and Movies —

To delete selected pictures and movies:

1

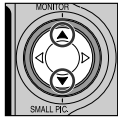

Highlight “Selected Images”

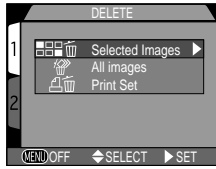

2

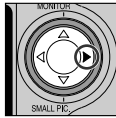

Display menu of thumbnail images



3

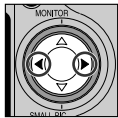

Highlight image



4

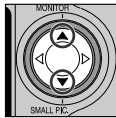

Press Multi selector to select image for deletion

- Selected images are marked by icon. Repeat steps 3 and 4 to select additional images for deletion. To deselect image, highlight and press $\blacktriangle/\blacktriangledown$ on the Multi selector. To exit without deleting images, press MENU button.



5

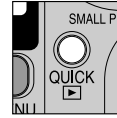

Press QUICK button to display a confirmation dialog.

- Press $\blacktriangle/\blacktriangledown$ on the Multi selector to highlight option, press \blacktriangleright to put choice into effect
- Select “Yes” to delete all selected images.
- Select “No” to return to playback menu without deleting images.

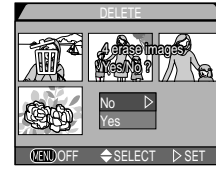

— Deleting All Pictures and Movies —

To delete all pictures on the CF memory card:

1

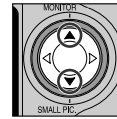

Highlight “All Images”

- Confirmation dialog is displayed.

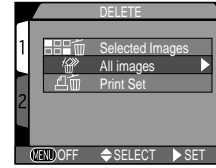

2

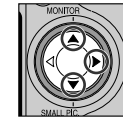

Press $\blacktriangle/\blacktriangledown$ to highlight option, press \blacktriangleright to put choice into effect:

- Select “Yes” to delete all images on memory card (protected images will not be deleted).
- Select “No” to return to playback menu without deleting images.



— Deleting the Current Print Order —

To delete print-order set in “Print Set” menu in the playback menu:

1

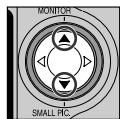

Highlight “Print Set”

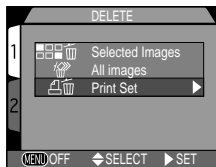

2

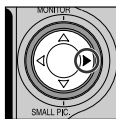

Press ►

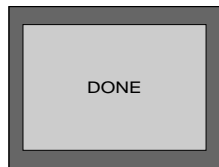

Marking Movie Files for Transfer

Please note that the transfer icon will be removed from movie files marked for transfer when the Print Set is deleted by selecting Print Set from the Delete option within the playback menu. Transfer settings for movie files must then be reset.

Before Deleting Pictures

Once deleted, pictures can not be recovered. Be sure that any pictures you would like to keep have been transferred to your computer.

Protected and Hide Images

- Images marked with a  icon are protected and can not be selected for deletion.
- Pictures hidden with the “Hide Image” option are not displayed in the thumbnail menu and cannot be deleted.

Selecting a Folder for Playback: The Folders Menu

The “Folders” item in the playback menu can be used to select images in all folders for playback or images in a selected folder.



1 Highlight desired folder

- To view images in all folders, select “All Folders”.

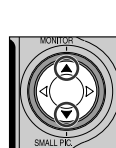

2 Press ►

- The most recent picture in the selected folder is displayed.

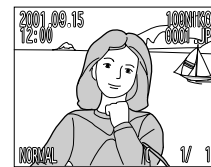

Each series of seventy pictures taken at a setting of “Ultra HS” is stored in a separate folder with a name consisting of “N_” followed by a three-digit number assigned by the camera. To view pictures taken at this setting, select the appropriate folder from the “Folders” menu.

See p. 109 for more information on “Folder Options”.

Automated Playback: The Slide-Show Menu

The slide-show option in the playback menu is used for automated sequential playback. When “Start” is selected in the slide-show menu, all images in the current folder that have not been hidden using the “Hide Image” option will be played back one after the other in the order recorded, with a pause between each image.

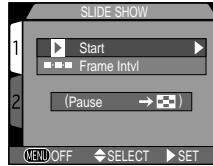

Starting a Slide Show

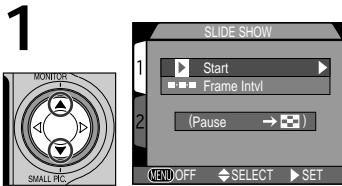

Highlight “Start”

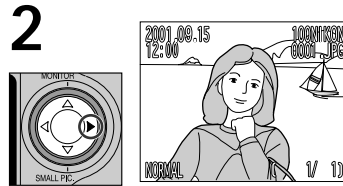

Press ► to start slide show

- Images are displayed one-by-one in order recorded, starting from oldest picture on card. Movies will be played back as still images of showing first frame of movie.

Auto Off

If the slide show lasts for more than half an hour, “Auto Off” (p. 115) will take effect after thirty minutes and the monitor will turn off automatically.

The following operations can be performed while a slide show is in progress:

To	Press	Description
Pause slide show		Press the button to pause the slide show. The dialog shown at right will be displayed. To restart the slide show, highlight Restart and press ► on the Multi selector.
End slide show	MENU	Press the MENU button to end the slide show and return to single-image playback.

Changing the Display Interval

The slide show menu shown opposite and the pause dialog shown above both contain a “Frame Intvl” option for changing the length of time each image in the slide show is displayed. To change display interval, highlight “Frame Intvl” and press ► on the Multi selector. The menu of interval settings shown at right will be displayed; highlight the desired setting and press ► on the Multi selector.

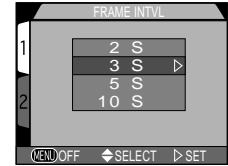

Frame Interval

Owing to differences in the file size of the images in the slide show and the speed at which they can be read from the CF memory card, the actual interval may differ from the value shown in the menu.

Small Pictures are not displayed in a slide show.

Safeguarding Valuable Images: The Protect Menu

Selecting “Protect” from the playback menu displays the menu shown at right, where you can select images to protect from accidental deletion. Protected files can not be deleted in review, single-image playback, or from the delete sub-menu. Note, however, that protected images will be deleted when a CF memory card is formatted.

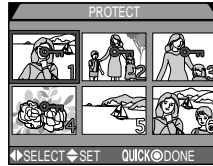

1 Highlight image

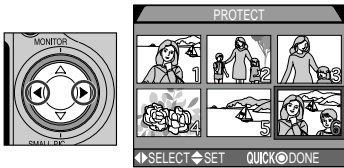

2 Press ▲/▼ to select image

- Selected images are marked by  icon. Repeat steps 1 and 2 to select additional images. To deselect image, highlight and press ▲/▼ on the Multi selector.

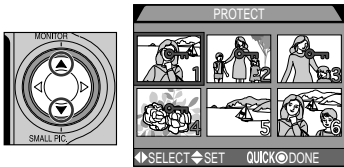

3 Press QUICK button to complete operation

- To exit “Protect” menu without changing protected status of images, press MENU button.

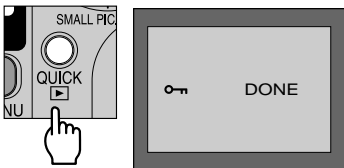

Hiding Images During Playback: The Hide Image Menu

When creating a slide show or showing pictures to an audience, you may want to use the “Hide Image” option to hide some of the pictures in the current folder. Hidden images are only visible in the “Hide Image” menu. They cannot be deleted in single-image playback or from the “Delete” sub-menu.

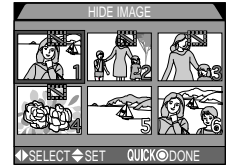

1 Press ◀/▶ to highlight desired thumbnail

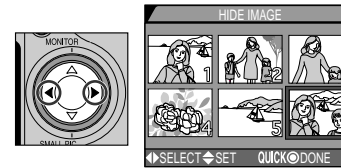

2 Press ▲/▼ to select image to be hidden

- Selected images are marked by  icon. Repeat steps 1 and 2 to select more images.
- To deselect, highlight and press ▲/▼ on the Multi selector.



3 Press QUICK button to complete operation

- To exit “Hide Image” menu without changing protected status of images, press MENU button.

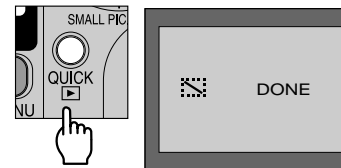

Ordering Prints: The Print-Set Menu

Selecting “Print Set” from the playback menu displays the menu shown at right. Here you can specify pictures to be printed, the number of prints, and the information to be included on each print. This information is stored on the CF memory card in Digital Print Order Format (DPOF). Once a print order has been created, the CF memory card can be removed from the camera and inserted in any DPOF-compatible device—be it your personal photo printer or a photofinisher’s print system—and images printed directly from the card.

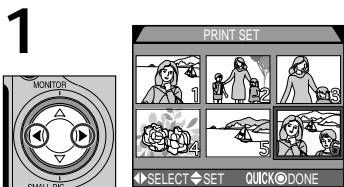
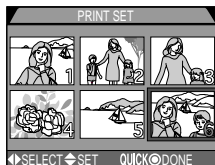

Highlight image

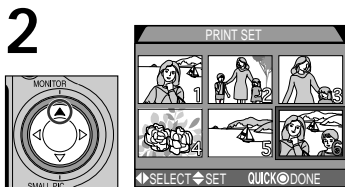

Press ▲ to select image

- Selected images are marked by icon.

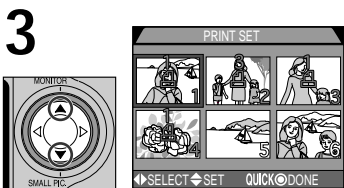

Use Multi selector to specify number of prints

- Press ▲ to increase (maximum 9), ▼ to decrease.
- To deselect image, press ▼ when number of prints is 1.
- Repeat steps 1–3 to select additional images.
- To exit without altering print order, press MENU button.

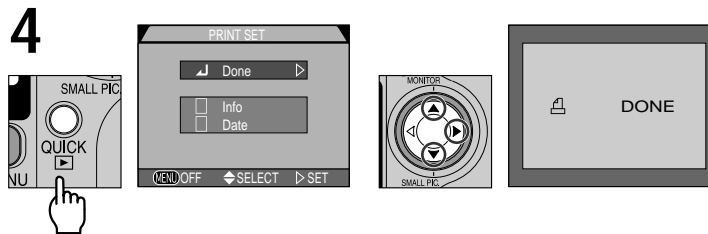

Press QUICK button to complete operation and display menu of print options; to highlight option, press ▲/▼

- To print shutter speed and aperture on all selected pictures, highlight “Info” and press . Check will appear in box next to item.
- To print date of recording on all selected photographs, highlight “Date” and press . Check will appear in box next to item.
- To deselect a checked item, highlight and press .
- To complete print order and return to playback, highlight “Done” and press . To exit without altering print order, press MENU button.

Deleting the Print Order

To delete the current print order when it is no longer needed, select “Print Set” from the “Delete” menu (p. 166).

Print Settings Created Using Other Cameras

If a CF memory card containing images with print settings created using any other model of camera is inserted into a COOLPIX885, such settings will not be recognized and must be reset using the COOLPIX885. The same applies if a card from a COOLPIX885 is inserted into any other model of camera.

Only one print-order can be stored on the CF memory card at a time.

Marking All Images for Transfer: The Transfer Menu

Selecting “Transfer” from the playback menu displays the menu shown at right. By default, photos and movies are automatically marked for transfer when they are recorded. The playback “Transfer” option is used when you want to remove transfer marking from all images, or to select all images for transfer after turning transfer marking off.

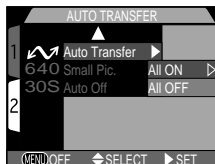

Option	Description
All ON	Mark all images on the CF memory card for transfer to a computer.
All OFF	Remove transfer marking from all images on the CF memory card.

Marking image files for transfer

Up to 999 images on a CF memory card can be marked for transfer. Image files of any file number can be transferred. To transfer 1000 or more images, use one of the following methods:

- 1) Transfer the images using Nikon View 4, not the TRANSFER button.
- 2) Transfer 999 images using the TRANSFER button, and unmark the images once they have been transferred. Then mark the remaining images for transfer and press the TRANSFER button once again.

Transfer Settings Created Using Other Models of Nikon Cameras

If a CF memory card containing images with transfer settings created using any other model of Nikon camera is inserted into a COOLPIX885, such settings will not be recognized and must be reset using the COOLPIX885. The same applies if a card from a COOLPIX885 is inserted into any other model of Nikon camera.

Selecting Small Picture Size: The Small Pic. Menu

Image size of the Small Pictures can be set to 640 x 480, 320 x 240, 160 x 120 or 96 x 72 pixels. Choosing a new Small Picture size from the “Small Pic.” sub-menu changes the size of the small picture created by pressing the ▼ SMALL PIC. button of the Multi selector, and the size of small pictures created there after will be recorded in the newly selected size.

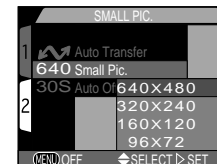

Image size	Small Picture size (pixels)
Large ↑ ↓ Small	640 x 480
	320 x 240
	160 x 120
	96 x 72

- Smaller the image size, faster the time it takes to distribute the images by e-mail and the web.
- The image quality of the Small Picture is set to BASIC.

See p. 76 for more information on creating Small Pictures

Television Playback: Connecting Your Camera to a Video Device

Using the EG-900 video cable provided with your camera, you can connect the COOLPIX885 to a television or VCR. The video device will show the same picture as is displayed in the camera monitor.

1 Connect the video cable to the camera

- Insert the black plug on the EG-900 into the camera's interface connector.

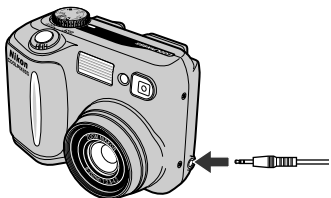

2 Connect the video cable to the video device

- Connect the yellow plug to the video-in jack on the television or VCR.

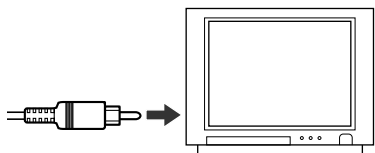

3 Tune the television to the video channel

4 Turn the camera on

- The television will mirror the image in the camera monitor.

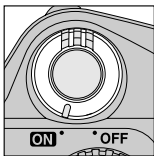

Use an AC Adapter

To prevent the display in the television from turning off whenever the camera enters sleep mode, connect the camera to an EH-21 AC adapter/battery charger (available separately). Note, however, that camera settings and picture info will not be displayed on the television screen when the camera monitor is off.

Choosing a Video Mode (p. 122)

The Video Mode item in the SETUP menu offers a choice of NTSC and PAL standards for video output. Be sure that the standard selected matches that of any video device to which you connect the camera.

PAL Video Mode (p. 122)

At a setting of PAL, the monitor will turn off when a video cable is connected. In movie mode, however, the monitor will turn on and output to the video device will be suspended.

By connecting your Nikon digital camera to a computer running Nikon View, you unleash its full potential. Images can be transferred to your computer and from there distributed electronically to family and friends. Selected images can be copied to a floppy disk directly from the camera's CF memory card, then delivered to a photofinisher, or you can save copies to your hard disk and use your favorite imaging software to retouch images or print copies on a color printer.

This section describes how to connect your camera to a computer running Nikon View using the UC-E1 Universal Serial Bus (USB) cable supplied with your camera. Users whose computers are not equipped with a USB interface can insert the camera CF memory card in a card reader or card slot, as described in this section.

Already Have Nikon View?

In order to transfer images to your computer using the UC-E1 USB cable, the COOLPIX885 requires the version of Nikon View 4 provided with the camera. If you have a version of Nikon View that was included with another Nikon digital camera, you will need to upgrade to the version provided with the COOLPIX885 as described in the *Nikon View Reference Manual* (on CD).

Before You Begin: Installing Nikon View

The first step to using Nikon View is to read the directions for installation. These are included on the reference CD provided with your camera.

1 Insert the reference CD in a CD-ROM drive

- After turning your computer on and waiting for the operating system to start up, place the reference CD in a CD-ROM drive.
- If you are using a Macintosh computer, the reference CD window will open automatically on the desktop. Windows users will need first to double-click the "My Computer" icon and then the "Nikon" icon to open the reference CD window.



INDEX.pdf

INDEX.pdf icon in the reference CD

Image Database Software

Depending on where you purchased your camera, the COOLPIX885 comes with Canto Cumulus, iView Media Pro, or Fotostation Easy image database software. See the reference CD for information on installing these applications. If you will be using Cumulus or iView Media Pro, remember to install the image database software before installing Nikon View. If you will be using Fotostation Easy, install Nikon View 4 first, and then install Fotostation Easy.

2 Install Adobe Acrobat Reader

- The installation instructions for Nikon View are in Portable Document Format (PDF). To view the instructions requires Adobe Acrobat Reader 4.0 or later. If Adobe Acrobat Reader is already installed on your system, proceed to Step 3.
- To install Adobe Acrobat Reader, double-click the folder for the language of your choice and then double-click the installer icon. The installer start-up screen will be displayed; follow the on-screen instructions to complete installation.

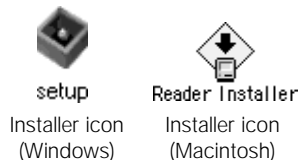

Startup screen (Windows)



Startup screen (Macintosh)

3 Read the installation instructions and install Nikon View

- Once installation is complete, double-click the "INDEX.pdf" icon in the Nikon window to view a clickable index of the documentation available for Nikon View. Follow the links to display the installation instructions for your computer system. If desired, you can print the installation instructions using the "Print..." command in the Acrobat Reader "File" menu and follow along during installation of Nikon View.



Before Starting the Install

Before installing image database software or Nikon View, be sure to exit all other programs, including Adobe Acrobat Reader and any virus-checking software.

Getting Connected: Connecting to Your Computer

Once you have installed Nikon View, you are ready to transfer pictures and movies to your computer. Images can be transferred either via a direct USB connection between the camera and computer, or by removing the memory card from the camera and inserting it in a card reader or PC card slot.



Direct Connection: Connecting Your Camera by Cable

If your computer is equipped with a built-in USB interface, you can connect the camera and computer using the UC-E1 USB cable provided with your camera. If your computer does not have a built-in USB connection, you can transfer images using a card reader or PC card slot (see following section).

1 Turn the computer on

- Turn the computer on and wait for the operating system to start up.

2 Select the images to be transferred

- After removing lens cap and turning the mode dial to , turn the camera on and press the  button to display a page of thumbnail images (p. 162). Check that the images you want to transfer are marked with a  icon. To select unmarked pictures for transfer or to deselect pictures already marked for transfer, highlight the picture and press the TRANSFER button. To select all images for transfer, select "All On" in the playback "Transfer" menu (p. 174).

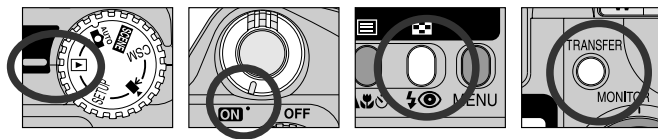

Note on Connecting to Your Computer

When the camera is connected to the computer and camera is turned on, the lens extends out. Make sure to remove the lens cap of the camera before connecting the camera to the computer.

"Hot Plug"

The USB interface supports "hot plug" connection of peripheral devices. This means that the camera can be on or off when you connect it to the computer. Note however that the procedure detailed in "Disconnecting the camera" (p. 184) must be followed when disconnecting the USB interface cable.

Transfer Time

Note that when large numbers of images are selected, some time will be required for transfer.

3 Connect the interface cable to the computer

- Connect the other end of the cable to the computer as shown at right.

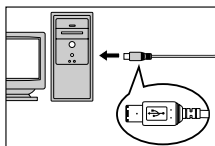

4 Connect the interface cable to the camera

- Connect the UC-E1 USB cable to the camera's interface connector. While the interface cable is connected, the monitor will be off and all controls except the power switch and TRANSFER button disabled.

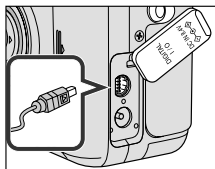

Connect the Camera Directly to the Computer

The camera may not function as expected when connected via a USB hub or keyboard.

Register the Camera with the System (Windows)

The first time the camera is connected to a Windows computer, the camera must be "registered" with the system so that the computer will know how to communicate with the camera. If you are using Windows Millennium Edition (Me) or Windows 2000, the computer will register the camera automatically the first time the camera is connected. The files needed to register the camera with Windows 98/98 Second Edition (SE) is contained on the Nikon View installer CD. Be sure the CD is inserted in the drive when you first connect your camera. Other versions of Windows do not support USB. More information on registering your camera can be found in Nikon View Reference Manual.

Use a Reliable Power Source

When transferring data between the camera and the computer, we recommend that you use an EH-21 AC adapter/battery charger (available separately) to ensure a reliable power supply. If the camera is running on battery power, be sure that the battery is charged. If possible, have spare batteries on hand. If the battery runs low, turn the camera off and replace the battery after verifying that the image transfer dialog is not displayed in the computer monitor.

5 Press the TRANSFER button

- Once the camera is turned on, Nikon View will automatically detect the camera. After Nikon View has started, press the TRANSFER button on the camera to copy all marked images from the CF memory card to the computer. The message "PREPARING TO TRANSFER" will appear in the camera monitor. After a brief pause, transfer will begin, and the message "TRANSFERRING IMAGE TO COMPUTER" will be displayed.

6 Disconnect the camera

- When all marked images have been transferred, the monitor will show "TRANSFER COMPLETED." Before disconnecting the cable or turning the camera off, you must remove the camera from the system as described below.

PREPARING
TO TRANSFER



TRANSFERRING
IMAGE TO
COMPUTER



TRANSFER COMPLETED

Interrupting Transfer

To end transfer before all marked pictures have been copied to the computer, click the "Cancel" button in the Nikon View transfer progress dialog. The message "TRANSFER CANCELLED" will appear in the camera monitor. Even though the message, "TRANSFER COMPLETED" may appear after transfer has been cancelled, transfer has not been successfully completed.

- See p. 121 for more information on selecting images for transfer as they are taken.
- See p. 174 for more information on selecting images for transfer after they are taken.

Disconnecting the Camera

When you want to disconnect the camera from the computer, follow the instructions below before turning the camera off or disconnecting the USB cable.

• Windows Millennium Edition/Windows 2000

Click the "Unplug or Eject Hardware" icon  in the taskbar and select "Stop USB Disk" from the menu that appears. If this step is not performed before the camera is disconnected or turned off, a warning will be displayed. Click "OK" to clear the warning from the screen.

• Windows 98/Windows 98SE

Double click My Computer icon, and right-click the removable disk corresponding to the camera. Select Eject from the menu that appears.

• Macintosh

Drag the "untitled" volume representing the camera into the Trash.

When a transfer error occurs, messages such as "TRANSFER ERROR" or "COMMUNICATION ERROR" will appear in the monitor. The error message may be followed by the message "TRANSFER COMPLETED", although note that transfer is NOT complete when an error occurs. Remember to follow the above disconnection procedure when disconnecting the camera after a transfer error.

Formatting CF memory cards

If a CF memory card inserted into the camera is formatted using Explorer or My Computer (Windows), or Erase Disk is selected from the Special menu (Macintosh), all images on the card will be deleted.

Disconnecting the Camera During Image Transfer

Confirm that image transfer is completed and the message "TRANSFER COMPLETED" is displayed in the camera monitor, before performing any of the above operations.

Do not turn the camera off, disconnect the cable or remove the CF memory card while the transfer progress meter is displayed in the computer monitor.

Reading Pictures from CF Memory Cards

If you have a CompactFlash™ card reader or your computer is equipped with a PC card slot, you can transfer images directly from the memory card. Before inserting the CF memory card in a card reader or card slot, turn the camera off and remove the card from the camera.

Using a CompactFlash™ Card Reader

Before using your card reader, be sure to read all documentation provided by the manufacturer. Then follow the steps below to transfer images from the CF memory card using the card reader.

1 Turn the computer on

- Turn the computer on and wait for the operating system to start up.

2 Insert the CF memory card into the card reader

- If Nikon View has already been installed, and the CF memory card is from a Nikon Digital Camera, Nikon View will automatically detect the card. See the Nikon View Reference Manual for information on transferring images to your computer.

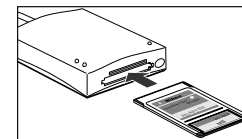

"CompactFlash™ Card Reader"

A CompactFlash™ (CF) card reader is a device that allows your computer to read memory cards of the type used in your camera. CF card readers come in many varieties, ranging from inexpensive USB card readers to the built-in readers found on some newer computers.

"PC Card Slot"

Commonly found on laptop computers, PC card slots take "PCMCIA" (Personal Computer Memory Card International Association) cards, which are larger than the CompactFlash™ memory cards used in your camera. To read CompactFlash™ memory cards using a PC card slot, you will require an EC-AD1 PC-card adapter, available separately from Nikon.

Viewing the Nikon View Reference Manual

The *Nikon View Reference Manual* is stored in Portable Document Format (PDF) on the reference CD provided with your camera. To view the Reference Manual, double-click the "INDEX.pdf" icon in the root directory of the reference CD (p. 179).

Using a PC Card Slot

1 Insert the CF memory card into a PC-card adapter

- Insert the CF memory card into a PC-card adapter as shown at right.

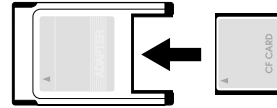

2 Turn the computer on

- Turn the computer on and wait for the operating system to start up.

3 Insert the adapter into the card slot

- If Nikon View has already been installed, and the CF memory card is from a Nikon Digital Camera, Nikon View will automatically detect the card. See the Nikon View Reference Manual for information on transferring images to your computer.

Removing the CF Memory Card

Be sure that image transfer is complete before removing the CF memory card from the card reader or PC card slot. Do not remove the card while the transfer progress meter is displayed in the computer monitor.



Before removing the CF memory card from a PC card slot or USB card reader, you will need to remove the card from the system.

Windows

Click the "Unplug or Eject Hardware" icon  in the taskbar and remove the memory card from the system. If this step is omitted, a warning will be displayed. Click "OK" to clear the warning from the screen.



Macintosh

Drag the "untitled" volume that represents the CF memory card into the Trash.



This section provides information on:

Caring for Your Camerap. 188

Read this section for tips on cleaning and storing your camera.

Optional Accessories.....p. 189

Learn what optional accessories are available for the COOLPIX885.

Web Resourcesp. 190

Where to get help on line.

Troubleshootingp. 191-196

Read this section for help when your camera does not function as expected.

Specifications.....p. 197-201

Technical data for the COOLPIX885.

Caring for Your Camera

Cleaning

Lens/Viewfinder	The key to cleaning these glass parts is to not touch them with your fingers. Use a blower (typically a small device with a rubber bulb attached to one end that you pump to produce a stream of air out the other) to remove dust or lint. To remove fingerprints or other stains that can not be removed with a blower, wipe the lens or viewfinder with a soft cloth, using a spiral motion that starts in the center of the lens and works out to the edges.
Monitor	Remove dust or lint with a blower. To remove fingerprints and other stains, clean the monitor with a soft, dry cloth, being careful not to apply pressure.
Camera Body	Use a blower to remove dust and lint, then wipe gently with a soft, dry cloth. After using the camera at the beach or seaside, wipe off any sand or salt with a cloth lightly dampened with fresh water, then dry thoroughly.

Do not use alcohol, thinner, or other volatile chemicals.

Storage

When the camera will not be used for an extended period, remove the battery after checking to make sure that the camera is off. Do not store your camera in locations that:

- are poorly ventilated or damp
- are next to equipment that produces strong electromagnetic fields, such as televisions or radios
- are exposed to temperatures above 50°C (122°F) or below -10°C (14°F)
- are subject to humidities of over 60%

Optional Accessories

At the time of writing, the following optional accessories were available for the COOLPIX885. Contact your retailer or local Nikon representative for details.

AC adapter/battery charger	EH-21 AC adapter/battery charger
Rechargeable battery	EN-EL1 rechargeable Li-ion battery (supplied in some areas)
Carrying case	CS-E885 Soft Case
CompactFlash memory cards and adapters	<ul style="list-style-type: none"> • EC-CF 64 MB CompactFlash memory card • EC-CF 96 MB CompactFlash memory card • EC-AD1 PC-card adapter
Lens Adapter	UR-E4 step down ring lens adapter
Lens Converter and Slide copying adapter (UR-E4 step down ring lens adapter required)	<ul style="list-style-type: none"> • WC-E24*/WC-E63 Wideangle converter • TC-E2 (2x)/TC-E3ED (3x) Telephoto converter • FC-E8 fisheye lens converter • ES-E28 slide-copying adapter <p>* Not available in some areas.</p>
Remote release cable	MC-EU1 remote cord

Note on using remote release cable

The remote cord does not function when the camera is set to Movie, Continuous or VGA Sequence.

Approved Memory Cards

In addition to the memory cards listed above, the following memory cards have been tested and approved for use in the COOLPIX885:

- SanDisk SDCFB series 16 MB, 32 MB, 48 MB, 64 MB, 96 MB, and 128 MB
- Lexar Media 4X USB series 8 MB, 16 MB, 32 MB, 48 MB, 64 MB, and 80 MB
- Lexar Media 8X USB series 8 MB, 16 MB, 32 MB, 48 MB, 64 MB, and 80 MB
- Lexar Media 10X USB series 128 MB and 160 MB

Operation is not guaranteed with other makes of memory card. For more details on the above cards, please contact the manufacturer.

Web Resources

At the time of writing, the following on-line resources were available for users of Nikon digital imaging equipment:

For Product Information and Tips

- For users in the USA: <http://www.nikonusa.com/>
- For users in the Europe: <http://www.nikon-euro.com/>
- For users in the Asia, Oceania, the Middle East, and Africa: <http://www.nikon-asia.com/>

For Contact Information









Contact information for the Nikon representative in your area may be found at:

<http://www.nikon-image.com/eng/>

Troubleshooting

If your camera fails to function as expected, check the list of common problems below before consulting your retailer or Nikon representative. Refer to the page numbers listed in the rightmost column for information on solving the problems listed here.







Problem	Possible Cause	Page
Monitor is blank	• Camera is off.	24
	• Battery is not correctly inserted or battery-chamber cover is not fully closed.	44
	• Battery is exhausted.	50
	• EH-21 AC adapter/battery charger (available separately) is not properly connected.	46
	• Camera is in sleep mode. Press shutter release button halfway.	115
	• Monitor is off. Press ▲ on Multi selector to turn monitor on.	59, 158
	• PAL is selected in Video Mode menu and video cable is connected.	122
No indicators appear in monitor	• Indicators are hidden. In shooting mode, press ▲ on Multi selector until indicators are displayed.	59
	• Slide show is in progress.	168
Monitor is hard to read	• Monitor brightness requires adjustment.	114
	• Monitor is dirty.	188
No picture is taken when shutter release button is fully pressed	• Camera is in playback or SETUP mode.	89
	• Battery is exhausted.	50
	• Number of exposures remaining is zero: not enough memory remaining.	56
	• AF light flickers: camera unable to focus.	60
	• Flash light flickers: flash is charging.	99
	• Message "MEMORY CARD IS NOT FORMATTED" appears in monitor: CF memory card is not formatted for use in COOLPIX885.	48
	• Message "NO MEMORY CARD" appears in monitor: no CF memory card in camera.	47









Problem	Possible Cause	Page	
Pictures are too bright (overexposed)	<ul style="list-style-type: none"> Exposure compensation is too high. 	100	
Pictures are too dark (underexposed)	<ul style="list-style-type: none"> Flash is off. Flash window blocked. Subject is outside range of flash. Exposure compensation is too low. 	97 58 199 100	
Pictures are out of focus	<ul style="list-style-type: none"> Subject was not in focus area when shutter release button pressed halfway. AF light flashes rapidly: camera unable to focus. 	60 60	
Pictures are blurred	<ul style="list-style-type: none"> Camera shook during shot. 	58	
	<ul style="list-style-type: none"> When lighting is poor: <ul style="list-style-type: none"> Use the flash Zoom the camera out 	97 90	
	<ul style="list-style-type: none"> If zooming the camera out does not help and you do not want to or can not use the flash: <ul style="list-style-type: none"> Use Best-Shot Selector (BSS) Use the self-timer Use a tripod 	141 95	
Flash does not fire	<ul style="list-style-type: none"> Flash is set to Flash Cancel. 	98	
	<ul style="list-style-type: none"> Flash is off. Note that flash turns off automatically when: <ul style="list-style-type: none"> Camera is in  (landscape),  (sunset),  (night landscape),  (museum),  (fireworks show),  (close up) or  (movie) mode Focus is set to  (infinity) Setting other than "Single" selected in "Continuous" sub-menu Setting other than "Normal" selected in "Lens" sub-menu "AE Lock" option in "Exposure Options" sub-menu is on Best-Shot Selector (BSS) is on Battery level is low. 	98 65-67 89 93 139 145 148 141 50	

Problem	Possible Cause	Page
Pictures can not be played back	<ul style="list-style-type: none"> Picture has been overwritten or renamed by a computer or another make of camera. 	—
Television does not mirror image in monitor	<ul style="list-style-type: none"> Video cable not correctly connected. Television not tuned to video channel. Video Mode setting does not match video device. 	176 176 122
Nikon View does not start when camera connected or CF memory card inserted in card reader or card slot	<ul style="list-style-type: none"> Camera is off. EH-21 AC adapter/battery charger (available separately) is not properly connected, or battery is dead. Interface cable not correctly connected, or card not properly inserted in card reader, card adapter, or card slot. <p>See <i>Nikon View Reference Manual</i> for further information on troubleshooting Nikon View.</p>	24 46 182, 185, 186

Error Messages

The following table lists the error messages and other warnings that appear in the monitor and how to deal with them.

Display	Problem	Solution	Page
WARNING!! Remove Lens Cap!	Camera turned on with lens cap in place.	Turn camera off and remove lens cap.	43
 (Flashes)	Clock calendar not set.	Set clock calendar to current data and time.	52
 (Flashes)	Battery exhausted.	Turn camera off and replace battery.	44
WARNING!! BATTERY EXHAUSTED	Battery exhausted.	Turn camera off and replace battery.	44
WARNING! Mode dial is not in the proper position	Mode dial is positioned between two modes.	Adjust mode dial to select desired mode.	25
WARNING! No menu in AUTO mode Please use another mode	MENU button pressed in AUTO mode.	Turn mode dial to setting other than AUTO or  movie mode before using the menus.	25
WARNING! No menu in  mode	MENU button pressed in  movie mode.		
WARNING!! Please wait to camera to finish recording	Camera turned off or new mode selected while images are being recorded to memory card.	Message clears from display automatically when camera finishes writing data to card.	62
 NO CARD PRESENT	Camera cannot detect CF memory card.	Turn camera off and confirm that CF memory card is correctly inserted.	47
 THIS CARD CANNOT BE USED	Error accessing CF memory card.	Use approved CF memory card.	189

Display	Problem	Solution	Page
 THIS CARD IS INCOMPATIBLE	Error accessing CF memory card.	Use approved CF memory card.	189
 MEMORY CARD IS NOT FORMATTED Format No 	Card has not been formatted for use in COOLPIX885.	Press  on Multi selector to highlight "Format" and press  to format card, or turn camera off and replace card.	48
 OUT OF MEMORY	Error occurs during shooting: Insufficient memory to record further pictures at current settings.	<ul style="list-style-type: none"> Reduce image quality or size. Delete pictures. Insert new card. 	103 164 47
	Error appears when you try to transfer images to computer: Not enough space on CF memory card to record information needed for transfer.	Disconnect camera, delete unwanted pictures and try again.	164 184
 IMAGE CANNOT BE SAVED	<ul style="list-style-type: none"> Error encountered while saving picture. Camera has run out of folder or file numbers. Small picture cannot be created with the image. 	<ul style="list-style-type: none"> Select "Off" or "Reset" in "Seq. Numbers" menu. Reformat CF memory card. Select image other than small picture or movie. 	116 48 76 89
CARD CONTAINS NO IMAGES	CF memory card contains no pictures.	<ul style="list-style-type: none"> Camera in review mode: half-press shutter release button to return to shooting mode. Mode dial set to  (playback mode): turn mode dial to another setting. 	24 25

Display	Problem	Solution	Page
ALL IMAGES ARE HIDDEN	All images in current folder are hidden.	Select another folder or use "Hide Image" to change hidden status of images in current folder.	108 171
FILE CONTAINS NO IMAGE DATA	File created by computer or different make of camera.	<ul style="list-style-type: none"> • Delete file. • Reformat CF memory card. 	164 48
THE FOLDER CANNOT BE DELETED	Folder contains hidden or protected pictures.	Folder can only be deleted if all images it contains are neither hidden nor protected pictures.	170, 171
COMMUNICATIONS ERROR	Interface cable disconnected or CF memory card removed while images are being transferred to computer.	If error message displayed in computer monitor, click "OK" to exit Nikon View. Turn camera off and reconnect cable or replace CF memory card, then turn camera on.	182, 185
NO IMAGES ARE MARKED FOR TRANSFER	No images marked with  icon when TRANSFER button pressed to transfer images to computer.	Disconnect camera and mark at least one image for transfer before connecting camera again.	73, 120, 174
TRANSFER ERROR	Error has occurred during image transfer.	Check that the camera is properly connected and that the battery is fully charged.	50, 183, 185, 186
SYSTEM ERROR	Error has occurred in camera's internal circuitry.	Turn camera off, unplug optional AC adapter (if using), remove and re-insert battery. If error persists, contact retailer or Nikon representative.	24 45

Specifications

Type	Digital camera E885
CCD	1/1.8-inch Interline Charge-Coupled Device (CCD)
Total pixels	3.37 million
Effective pixels	3.21 million
Image size	User can select from: <ul style="list-style-type: none"> • Full (2048 x 1536 pixels) • XGA (1024 x 768 pixels) • VGA (640 x 480 pixels) Four Small Picture sizes selectable (640 x 480, 320 x 240, 160 x 120 or 96 x 72 pixels)
Lens	<ul style="list-style-type: none"> • 3x Zoom Nikkor • F = 8-24 mm (35 mm camera format equivalent to 38-114 mm): f/2.8-f/4.9 • 9 elements in 8 groups
Digital zoom	4X digital zoom in 20 steps of 0.2X
Autofocus (AF) Focus modes	Contrast-detect through-the-lens (TTL) AF <ul style="list-style-type: none"> • Continuous AF (monitor on) • Single AF (monitor off) • Manual (49 positions, with focus confirmation indication)
Focus range	<ul style="list-style-type: none"> • 30 cm (1 ft.)-∞ at widest angle (W), 60 cm (2 ft.)-∞ at telephoto (T) • Macro mode (Autofocus): 4 cm (1.6 in.)-∞ at widest angle (W), 30 cm (1 ft.)-∞ at telephoto (T)
Viewfinder Frame coverage	Real-image zoom optical viewfinder with LED indication Approximately 80%
Monitor	1.5-inch 110,000-dot, low-temperature polysilicon TFT LCD with brightness and hue adjustment
Frame coverage	Approximately 97% (through/freeze image) Approximately 100% (playback mode)
Auto off	Can be selected from 30 sec. (default) and 1, 5 and 30 min.

Storage System	Design rule for Camera File systems, Digital Print-Order Format (DPOF) compliant HI (uncompressed TIFF-RGB) Compression JPEG-baseline-compliant:			
Media	<ul style="list-style-type: none"> • FINE (approx. 1/4) • NORMAL (approx. 1/8) • BASIC (approx. 1/16) QuickTime movies CompactFlash™ (CF) Card Type I			
Approximate Capacity	16 MB (64 MB)			
	FULL	XGA	VGA	
HI	1 (6)	—	—	
FINE	10 (40)	39 (159)	97 (390)	
NORMAL	20 (81)	76 (309)	177 (725)	
BASIC	39 (159)	144 (588)	324 (1300)	
Shooting modes	<ul style="list-style-type: none"> • Auto • Scene: Portrait, Party/Indoor, Night Portrait, Beach/Snow, Landscape, Sunset, Night Landscape, Museum, Fireworks Show, Close Up, Copy and Backlight • Custom (CSM) (includes shooting menu for control of White Balance, Metering, Continuous, Best-Shot Selector, Image Adjustment, Image Sharpening, Lens, Image Size & Quality, Sensitivity, Exposure Options, Focus Options, Auto Bracketing, Noise Reduction and CF Card Format) • Movie (up to 40 sec. of QVGA frames at 15 frames per second) 			
Capture modes	<ul style="list-style-type: none"> • Single • Continuous • Multi-Shot 16 (sixteen frames 1/16 in size) • VGA Sequence • Ultra HS (seventy QVGA images at approximately 30 fps) 			

Exposure metering Modes	Four-mode TTL metering <ul style="list-style-type: none"> • 256-segment Matrix • Center-Weighted • Spot • AF Spot
Exposure Control	<ul style="list-style-type: none"> • Exposure modes: Programmed Auto Manual • Exposure compensation (± 2.0 EV in steps of 1/3 EV) • Auto Exposure Bracketing • EV -3 to +15 (W) • EV + 1.4 to +16.6 (T)
Range (ISO 100 equivalent)	
Shutter Speed	Mechanical and charge-coupled electronic shutter 8-1/1000 sec., Bulb up to 60 sec. in M mode
Aperture Range	Electronically controlled preset aperture Two steps (f/2.8 and f/7.6 [W])
Sensitivity	ISO equivalent 100, 200, 400, Auto; can be set in CSM mode
White balance	Auto with TTL control, 5-mode manual with fine tuning, pre-set white balance, white balance bracketing
Self-timer	10 sec. or 3 sec. duration
Built-in Speedlight Range	0.4 to 3.7 m (1.3 to 12.1 ft.) (W) 0.4 to 2.3 m (1.3 to 7.5 ft.) (T)
Flash control Flash modes	Sensor flash system Auto, Flash Cancel (off), Red-Eye Reduction, Anytime Flash (fill-flash), Slow Sync
Playback Playback modes	Single frame, thumbnail (nine or four images), movie, zoom (4x), slide show, histogram indication/highlight point display, focus confirmation indication
Image deletion File attributes	User can delete all or selected frames User can set transfer, hide and protect attributes for each image

Interface	USB interface
Video output	User can choose from NTSC and PAL
I/O terminals	<ul style="list-style-type: none"> • DC input • Data output (video/USB)
Power requirements	<ul style="list-style-type: none"> • One rechargeable Nikon EN-EL1 lithium-ion battery, or six-volt 2CR5 (DL245) lithium battery • EH-21 AC adapter/battery charger (available separately)
Battery life	Approximately 90 minutes (EN-EL1) or 100 minutes 2CR5 (DL245) when using monitor at 20°C (68°F)
Operating environment Temperature Humidity	0 - 40°C (32 - 104°F) Under 85% (no condensation)
Dimensions (W x H x D)	Approximately 95 x 69 x 52 mm (3.7 x 2.7 x 2.0 in.)
Weight	Approximately 225 g (7.9 oz.) without battery and CompactFlash card

COOLPIX885 is supporting EPSON's "PRINT Image Matching".
 "PRINT Image Matching" is a technology which assists in producing vivid photo-quality prints from PIM-enabled Digital Cameras. To obtain this benefit, a digital camera and printer that are compatible with "PRINT Image Matching" are required.

Nikon View 4 System Requirements:

Macintosh

OS: Mac® OS8.6, 9, 9.1
 Models: iMac™, Power Macintosh® G3 (Blue/White), Power Macintosh™ G4 or later; iBook™, PowerBook® G3 (only built-in USB ports are supported) or later
 RAM: 32Mbyte, (64Mbyte or more recommended)
 Hard Disk: An additional amount equivalent to twice the capacity of the camera memory card required when Nikon View is running
 Display: 640 x 480 with 16-bit color (800 x 600 or greater, full color recommended)
 Others: CD-ROM drive
 USB interface (only built in USB ports supported)
 Mac® OS8.6 needs USB driver (ver. 1.3.5) on Apple's website

Windows

OS/Models: Windows® 98/98SE, Windows® 2000, Windows® ME pre-installed model
 CPU: MMX® Pentium® or later
 RAM: 32Mbyte (64Mbyte or more recommended)
 Hard Disk: An additional amount equivalent to twice the capacity of the camera memory card required when Nikon View is running
 Display: 640 x 480 with 16-bit color (800 x 600 or greater, Full color recommended)
 Others: CD-ROM drive, USB interface (only built-in USB ports supported)

- A** AE Lock.....P. 148
 Anytime Flash.....P. 98
 Auto (White Balance).....P. 135
 Auto Bracketing.....P. 152
 Auto Flash mode.....P. 98
 Autofocus mode.....P. 93
 Auto-Focus Mode.....P. 151
 Autofocus Target Area (AF Area mode).....P. 150
 AUTO mode.....P. 55-62
 Auto Off.....P. 115
 AUTO Sensitivity.....P. 131, 147
 Auto Transfer.....P. 121
- B** Back Light mode (SCENE).....P. 67
 Battery.....P. 44-46
 BASIC (image quality).....103-104
 Beach/Snow mode (SCENE).....P. 65
 Best Shot Selector.....P. 141
 Black-and-White.....P. 142
 Brightness.....P. 114, 142
 Built-in Speedlight.....P. 97
- C** Center-Weighted metering.....P. 137
 Close Up mode (SCENE).....P. 67
 Cloudy (White Balance).....P. 135
 CompactFlash™ memory card.....P. 47-49, 117, 189
 Continuous AF.....P. 94, 151
 Continuous.....P. 139
 Contrast.....P. 142
 Controls.....P. 118
 Copy mode (SCENE).....P. 67
 CSM (Custom) shooting mode.....P. 126-154
 CSM shooting menu.....P. 134-154
- D** Date/Time setting.....P. 52-53
 DCF (Design rule for Camera File System).....P. 108
 Delete.....P. 164-166
 Delete (Full-frame playback mode).....P. 71, 157
 Delete (Thumbnail playback mode).....P. 72, 162
 Delete all images.....P. 165
 Delete selected image(s).....P. 164-165
 Digital zoom.....P. 90-91
 Display mode.....P. 113
 Distance Units.....P. 151
 DPOF (Digital Print Order Format).....P. 83, 172
- E** Exposure Compensation.....P. 100, 149
 Exposure mode.....P. 148
 Exposure Options.....P. 148-149
- F** Fine (White Balance).....P. 135
 FINE mode (image quality).....P. 103-104
 Fireworks Show mode (SCENE).....P. 67
 Fisheye converter.....P. 145
 Flash Cancel.....P. 98
 Flash mode.....P. 98
 Fluorescent (White Balance).....P. 135
 Focus Confirmation display.....P. 159
 Focus mode.....P. 92-94
 Focus Options.....P. 150-151
 Folders setting.....P. 108-112, 167
 Folders > Options > New.....P. 109
 Folders > Options > Rename.....P. 110
 Folders > Options > Delete.....P. 111
 Formatting CF memory card.....P. 48-49, 117
 Full-frame playback mode.....P. 156-161
 FULL mode (image size).....P. 103, 106-107
 Full-Screen Review mode.....P. 71
- G** Green light.....P. 22, 60
- H** Hide Image.....P. 171
 HI mode (image quality).....P. 103-104
 Histogram display.....P. 159
 Hue.....P. 114
- I** Image Adjustment.....P. 142-143
 Image file name.....P. 116
 Image Quality.....P. 103-105
 Image Sharpening.....P. 144
 Image Size.....P. 103, 106-107
 Incandescent (White Balance).....P. 135
 Infinity mode.....P. 93
 info.txt.....P. 120
 Interval setting (Slide Show).....P. 169

L Landscape (SCENE)P. 66
 LanguageP. 51, 123
 Lens converterP. 145-146
 Long time exposureP. 129

M Macro Close-up modeP. 93
 Manual Exposure modeP. 127-129, 148
 Manual FocusP. 132-133
 Matrix MeteringP. 137
 Metering methodP. 137-138
 Multi-shot 16P. 139
 Monitor buttonP. 59, 158
 MOVP. 116
 MovieP. 89, 160
 Museum mode (SCENE)P. 66

N Night Landscape mode (SCENE)P. 66
 Night Portrait (SCENE)P. 65
 Noise ReductionP. 154
 NORMAL mode (imag quality)P. 103-104
 NTSCP. 122
 Number of remaining shotsP. 56

P PALP. 122
 Party/Indoor mode (SCENE)P. 65
 Playback menuP. 163-175
 Playback modeP. 155-177
 Portrait mode (SCENE)P. 65
 Preset White BalanceP. 135-136
 Print Set (DPOF)P. 172-173
 P Exposure modeP. 148
 ProtectP. 170

Q Quick Review modeP. 70

R Red-Eye ReductionP. 98
 Red-Eye Reduction lampP. 21, 98
 Red lightP. 22, 60
 Reset AllP. 124-125

S SCENE modeP. 63-67
 Self-timerP. 95
 SensitivityP. 147
 Sensitivity settingP. 130-131
 Seq. NumbersP. 116
 SETUP modeP. 102-125
 Shooting menuP. 134-154
 Single AFP. 94, 151
 Single shootingP. 139
 Slide showP. 168-169
 Slow Sync FlashP. 98
 Small pictureP. 76-79, 175
 Speedlight (White Balance)P. 135
 Spot AF AreaP. 137
 Spot meteringP. 137
 Sunset mode (SCENE)P. 66

T Telephoto converterP. 145
 Television playbackP. 176-177
 Thumbnail modeP. 72, 162
 TIFFP. 76, 104
 TransferP. 73, 174

U Ultra HS shootingP. 139
 USBP. 181-184

V VGA Sequence shootingP. 139
 VGA (image size)P. 103, 106-107
 Video ModeP. 122

W White BalanceP. 135
 White Balance BracketingP. 153
 Wide-angle converterP. 145

X XGA (image size)P. 103, 106-107

Z ZoomP. 58, 90-91
 Zooming inP. 161

No reproduction in any form of this manual, in whole or in part (except for brief quotation in critical articles or reviews), may be made without written authorisation from NIKON CORPORATION.

Nikon

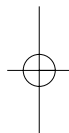

NIKON CORPORATION

FUJI BLDG., 2-3, MARUNOUCHI 3-CHOME,
CHIYODA-KU, TOKYO 100-8331, JAPAN

Printed in Japan K115000401 (11)
6MAA0211-04